



USER'S MANUAL

375X SERIES ELECTRONIC LOAD

Contents

Safety Instruction	1
Chapter I General Introduction	3
1.1 Function Features	3
1.2 Front Panel	4
1.3 Rear Panel	5
1.4 Keypad Function	5
1.5 Annunciators	7
1.6 Display	8
1.6.1 Main Menu List	8
1.6.2 Port Configuration Menu	9
1.6.3 Transient Operation Menu	10
1.6.4 List Operation Menu	11
1.6.5 Basic Mode Menu & LCD Information	13
1.6.5.1 CC Mode Menu	13
1.6.5.2 CR Mode Menu	14
1.6.5.3 CV Mode Menu	15
1.6.5.4 CP Mode Menu	16
1.6.5.5 +CV Mode Menu	18
1.6.6 Error & Alarm Menu	19
1.6.7 Save Menu	19
1.6.7.1 Application Save Menu	19
1.6.7.2 Recall Save Menu	20
1.7 Remote Programming	20
Chapter II Functions and Features	21
2.1 Local & Remote Control	21
2.2 Main Functions	21
2.3 Basic Test Functions	22
2.3.1 CC Test	22
2.3.1.1 Current Setting Range	23
2.3.1.2 Immediate Current Level	23
2.3.1.3 Triggered Current Level	23
2.3.1.4 Transient Current Level	24
2.3.1.5 Software Current Level	24
2.3.2 CV Test	24
2.3.2.1 Voltage Setting Range	25
2.3.2.2 Immediate Voltage Level	25
2.3.2.3 Triggered Voltage Level	26
2.3.2.4 Transient Voltage Level	26
2.3.3 CR Test	26
2.3.3.1 Resistance Setting Range	27
2.3.3.2 Immediate Resistance Level	27
2.3.3.3 Triggered Resistance Level	27

2.3.3.4 Transient Resistance Level	28
2.3.4 CP Test	28
2.3.4.1 Power Setting Range	29
2.3.4.2 Immediate Power Level	29
2.3.4.3 Triggered Power Level	29
2.3.5 CC+CP Test	30
2.3.6 CR+CV Test	30
2.3.7 CP+CV Test	31
2.4 Transient Operation	31
2.4.1 Continuous Transient Operation	32
2.4.2 Pulsed Transient Operation	34
2.4.3 Toggled Transient Operation	36
2.5 List Operation	38
2.6 Triggered Operation	39
2.7 Input Control	40
2.7.1 ON/OFF of Eload Input	40
2.7.2 Von Point/Von Latch	40
2.7.3 Current Limit Function in CV Mode	41
2.7.4 Current Rising Rate	42
2.7.5 Current Falling Rate	42
2.8 Measurement Function	43
2.9 Saving and Recalling	43
2.10 Reading Remote Program Errors	45
2.11 Status Report	45
2.12 Protection and Alarm Function	45
2.12.1 Clearing Latched Protection	46
2.12.2 Overvoltage	46
2.12.3 Overcurrent	46
2.12.4 Overpower	47
2.12.5 Overtemperature	47
2.12.6 Reverse Polarity	48
Chapter III Installation	49
3.1 Initial Check	49
3.2 Environment/Installation Location	49
3.3 PowerOn/Self-check	51
3.4 Connection of the Rear Panel	52
3.5 Connection of the Front Panel	54
3.6 Wiring	55
Chapter IV Local Operation	60
4.1 Local Control	60
4.2 Main Operation of the Front Panel	60
4.3 Connecting to the Power Supply	61

4.4 ON/OFF of Eload Input	61
4.5 Basic Operation	61
4.5.1 CC Mode	62
4.5.2 CV Mode	64
4.5.3 CR Mode	66
4.5.4 CP Mode	68
4.6 +CV Mode	70
4.6.1 CC+CV Mode	70
4.6.2 CR+CV Mode	71
4.6.3 CP+CV Mode	72
4.7 Transient Operation	73
4.7.1 Continuous Transient Operation	73
4.7.2 Pulsed Transient Operation	75
4.7.3 Toggled Transient Operation	77
4.8 List Operation	79
4.8.1 List Editing	80
4.8.2 Starting/Stopping the List	83
4.9 Saving and Recalling	84
4.10 Checking and Clearing Protection Setting	86
4.11 Trigger Operation	87
4.12 Main Menu	87
4.12.1 Buzzer	88
4.12.2 Encoder	88
4.12.3 Trigger	89
4.12.4 Calibration	89
4.12.5 Information	89
4.12.6 Safety Code	90
4.12.7 Date	91
4.12.8 Time	92
4.12.9 Language	92
4.12.10 System Default	93
Chapter V Remote Programming Operation	94
5.1 Communication Interface	94
5.1.1 RS232	94
5.1.2 USB	94
5.1.3 GPIB	95
5.2 Remote Programming Display	98
5.3 Sending Remote Setting Commands	98
5.4 Returning Data	98
5.5 Remote Programming Commands	98
5.5.1 Basic Test Mode	99
5.5.2 Transient Level	99

5.5.3 Programmable Current Protection	99
5.6 CC Mode Example	99
5.7 CV Mode Example	100
5.8 CR Mode Example	100
5.9 Continuous Transient Operation Example	100
5.10 Pulsed Transient Operation Example	101
Specifications	102
Frame Diagram	110
Declarations	113

Safety Instruction

This chapter contains the important safety instructions that the users must follow during operation and storage. Please read the contents carefully before operation to ensure the safe and optimal use.

Safety Guides:

- 1. Do not place heavy objects on the instrument. Notes: Only two units can be placed vertically.**
- 2. To avoid serious impact or improper placement and damage to the instrument.**
- 3. To avoid the electrostatic discharge to the instrument.**
- 4. Please use the matched cable. Please do not use the naked cable.**
- 5. Please do not block or obstruct the ventilation of the fan.**
- 6. Please do not disassemble the instrument unless you are qualified as service personnel.**
- 7. The instrument is not for the measurements performed for CAT I, II and IV.**

● (Measure Categories) EN6100-1:2010 specifies the measurement categories and their requirements as follows. The 375XA falls under category II.

- Measurement category IV is measurement performed at the source of low-voltage installation.
- Measurement category III is for measurement performed in the building installation.
- Measurement category II is for measurement performed on the circuit directly connected to the low voltage installation.
- Measurement category I is for measurement performed on circuits not directly connected to the main.

8. Power Supply

- AC Input Voltage: 100~120VAC/200~240VAC (90~132VAC/180~250VAC)
- Frequency: 47~63Hz
- Power: 3751A 80VA Max
- Connect the protective grounding conductor of the AC power cord to an earth ground, to avoid electrical shock.

9. Cleaning

Disconnect the power before cleaning. Use a soft cloth dampened in a solution of mild detergent and water. Do not spray any liquid. Do not use chemicals or cleaners containing harsh

material such as benzene, toluene, xylene and acetone.

10. Operation Environment

- Location: Indoor, no direct sunlight, dust free, almost non-conductive pollution
- Temperature: 0°C~40°C
- Humidity: 0~90% RH
- **(Pollution Degrees)** EN6100-1:2010 specifies the pollution degree and their requirements as follows.
 - The 375XA falls under degree II.
 - Pollution refers to “addition of foreign matter, solid, liquid or gaseous (ionized gases), that may produce a reduction of dielectric strength or surface resistivity”.
 - Pollution degree I: No pollution or only dry, non-conductive pollution occurs. The pollution has no influence.
 - Pollution degree II: Normally only non-conductive pollution occurs. Occasionally, however, a temporary conductivity caused by condensation must be expected.
 - Pollution degree III: Conductive pollution occurs, or dry, non-conductive pollution occurs which becomes conductive due to condensation which is expected. In such conditions, equipment is normally protected against exposure to direct sunlight, precipitation, and full wind pressure, but neither temperature nor humidity is controlled.

11. Storage Environment

- Location: Indoor
- Temperature: -20°C~70°C
- Humidity: <90% RH

12. Disposal

Do not dispose this instrument as unsorted municipal waste. Please use a separate collection facility or contact the supplier from which this instrument was purchased. Please make sure discarded electrical waste is properly recycled to reduce environment impact.

Chapter I General Introduction

General Introduction of 375XA Eload

ARRAY 375XA electronic load is a new-generation high-performance programmable electronic load researched by ARRAY ELECTRONIC CO., LTD, which provides powerful test function and friendly human-machine interface. The electronic load is equipped with RS232, USB and GPIB interface and supports SCPI standard commands for programmable instrumentation and LabView development platform, which is widely used in the scientific research and production field of aerospace, shipbuilding, auto electronics, solar cell and fuel cell.

The “electronic load”, “Eload” or “load” in the manual indicates ARRAY 375XA electronic load without following instructions.

1.1 Function Features

The main functions and features of ARRAY 375XA Eload are as below:

- Four basic testing modes: CC, CV, CR and CP; twelve basic working modes: CCL, CCH, CVL, CVH, CRL, CRH, CP, CCL+CV, CCH+CV, CRL+CV, CRH+CV, CP+CV;
- The 16 bit D/A converters and 24 bit A/D converters incorporated, provide the equipment with greatly enhanced setting and measurement resolution. The D/A conversion rate can reach 500 KHz and the high-speed performance is overall increased;
- Minimum operating voltage is less than 1.8V at the load's full rated current. The maximum current can be achieved even though the input voltage is 0V, which is especially suitable for the fuel cell, solar cell, auto charger and other new energy test application. The load is with powerful protection function and is reliable in the most complicated test environment;
- High resolution TFT-LCD display;
- High-speed transient test function: the maximum test frequency can reach 50 kHz and the current response speed can be 15A/us.
- Powerful sequential test function: the minimum step time is 10us and the maximum step time is 99999s. Cyclic times can be set freely and can be chained to another sequence to realize more complex test procedure;

- The high-efficiency intelligent cooling system can ensure the equipment has a long-term, full-power, trouble-free and continuous work;
- Automatic ON/OFF function effectively simplify the test operation;
- The combined use of knob and number keypad makes the operation more convenient;
- Save/Recall function can save multiple groups of common settings;
- With OCP, OPP, OTP protection function and OV, RV alarm function;
- Supporting SCPI and LabView and providing necessary PC software.

1.2 Front Panel

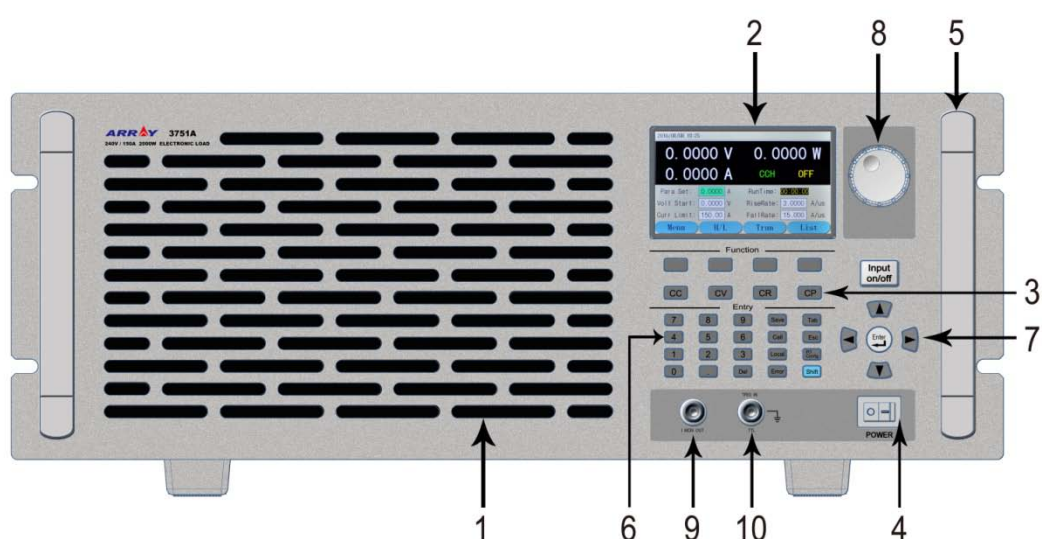

1	Air Inlet	Air inlet of the cooling air dust
2	LCD display	To display the state, test value and setting parameter of the instrument
3	Operation mode key	To switch the operation mode of the instrument
4	Power	Power ON/OFF
5	Handle	To handle the instrument
6	Number pad & function keys	To enter the numbers and the functions
7	Direction keys & enter key	To move the cursor and to confirm
8	Knob	To increase /decrease values
9	Current monitor terminal	To isolate the output after the test of the present current
10	External trigger input terminal	To input the external trigger signal

1.3 Rear Panel

The connecting terminals on the rear panel of 375XA series Eload include: the input terminals (INPUT+ and INPUT-) and voltage test terminals (SENSE+SENSE-), as shown in follows

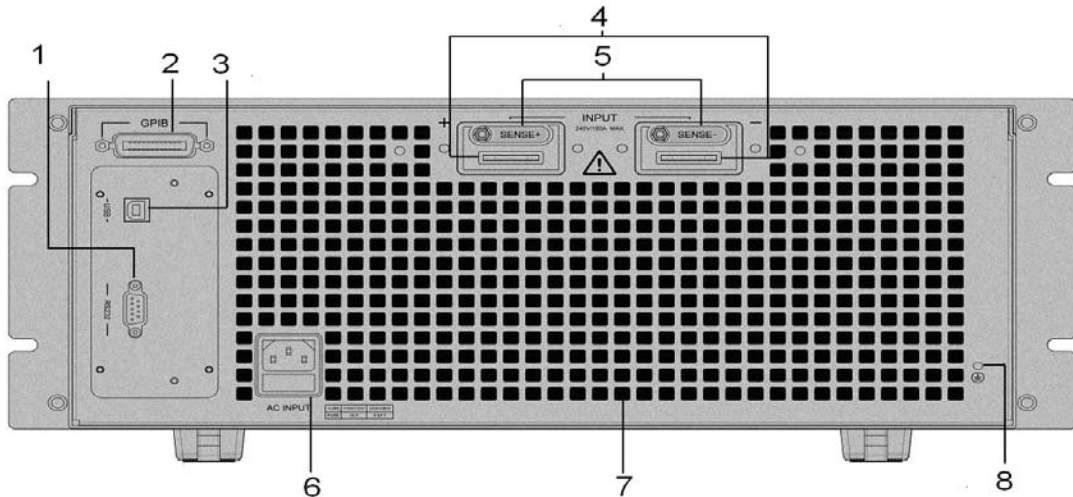

1. RS232 interface
2. GPIB interface (optional)
3. USB interface
4. Input terminal
5. Voltage test terminal
6. Power input socket & fuse
7. Air outlet
8. Ground terminal: to connect the earth during rack system installation

1.4 Keypad Function

There are four types of keys: function keys, number keys, alternative function keys and direction keys on the keypad. On the alternative function compound key, the black fond is the first function and the blue fond is the alternative function. For example, CV is the first function of  key and +CV is the alternative function. If the alternative function is needed to be used, press































 key first and then press the corresponding compound key.



Table 1-1 Key Explanation:

	Number 0
	Number 1
	Number 2
	Number 3
	Number 4
	Number 5
	Number 6
	Number 7
	Number 8
	Number 9
	Dot
	Clear
	Epitope shift key
	Save key
	Recall key
	Input ON/OFF key
	Confirmation key

	Left key
	Right key
	Upper key
	Down key
	Delete key
	Local key
	Error code display key
	I/O port configuration key
	CC mode selection key
	CV mode selection key
	CR mode selection key
	CP mode selection key
	Alternative function shift key

1.5 Annunciators

Table 1-3, Annunciator Explanations:

	Green light be on when the input being on
	Yellow light be on when the input being standby

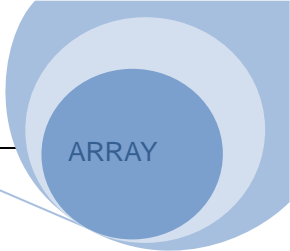

1.6 Display

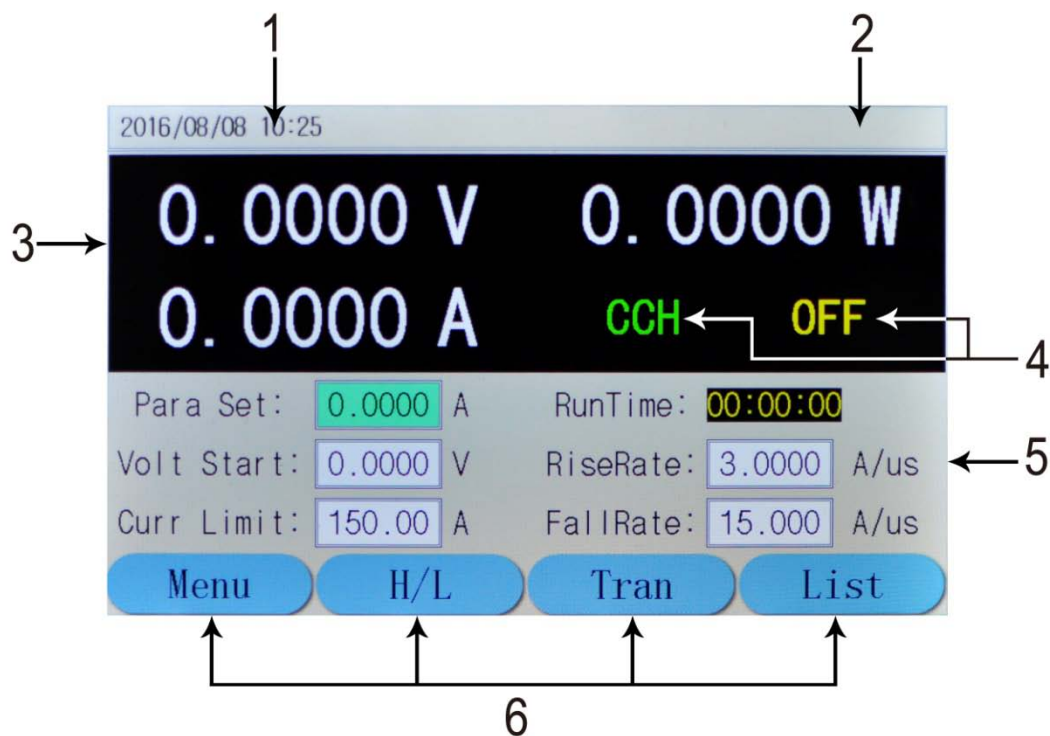

- | | |
|--------------------------|---|
| 1. Date and Time | To display the current date and time |
| 2. System State | To display the current system state |
| 3. Test Value | To display the current voltage, current and power value |
| 4. Operation State | To display the current operation mode and the input state |
| 5. Current setting Value | To display the current setting value |
| 6. Soft Key | To indicate the function of the key below the screen |

Description of the Main Menu

1.6.1 Main Menu List

Press dynamic  key to enter the main menu as shown in the following diagram:



The contents of the main menu are as the follows:

Beeper	To control the buzzer work or not;
Encoder	To control the encoder work or not;
Trigger	To control the trigger work or not;
Calibration	To calibrate the accuracy of the Eload, for details please see Calibration Methods ;
Information	To display the factory setting;
Security Code	To set the security code for the instrument to avoid the error operation of the Calibration menu;
Date	To adjust the current date of the system;
Time	To adjust the current time of the system;
Language	To swift the current language of the system;
Default Factory Value	The current system can be returned to the default factory value.

1.6.2 Port Configuration Menu

Press  key to enter the I/O configuration menu as follows:



Port Configuration		Com Port	USB	GPIB
RS232 Interface	Baud Rate	2400	9600	19200 38400 57600 115200
	Parity Bit	Non Parity/	Even Parity/	Odd Parity
	Data Bit	8 Bit	9 Bit	
	Stop Bit	1 Bit	2 Bit	
USB Interface		USB		
GPIB Interface	GPIB Address	Address Value		

1.6.3 Transient Operation Menu

In basic mode, press dynamic  key to enter the corresponding transient operation menu. The transient operation menu is as follows:



Function	Explanation	Parameter Example
L Level	Transient Low Level	1.000A
H Level	Transient High Level	6.000A
LowTime	Time for transient low level	0.6s
HighTime	Time for transient high level	0.6s
RiseTime	Time for transient rising edge	0.01s
FallTime	Time for transient falling edge	0.01s
Mode	Continuous (Cont) Pulse (Puls) Toggle (Togg)	Cont





Notes: Transient operation may be used in CC, CV, CR and CP modes.



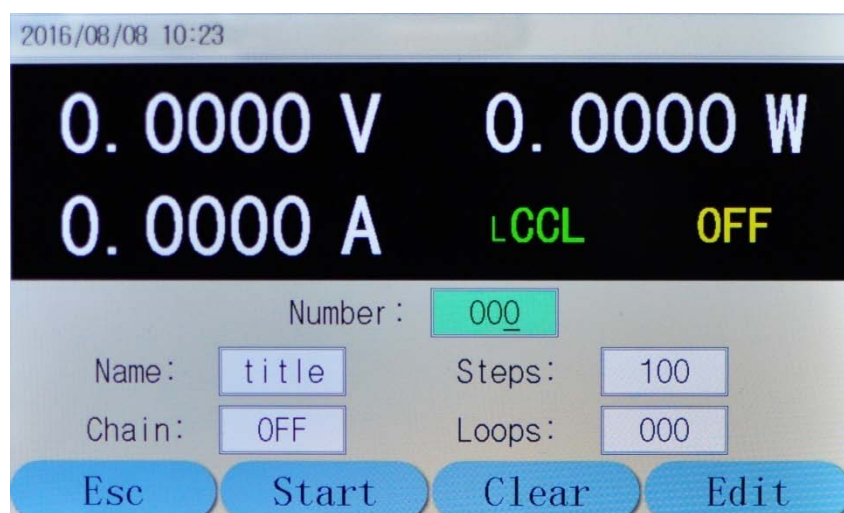

1.6.4 List Operation Menu

In basic mode, press dynamic **List** key to enter the corresponding list operation menu.

The list operation menu is as follows:

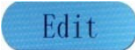

Number	List Steps (0-19)
Name	List Name (5 characters)
Total Steps	Total steps of list operation
Execution Times	Loop Times (1-999)
Link	Link (0-19, off)
 key	Press this dynamic key to return to the main menu;
 key	Press this key to switch between CCL and CCH;
 key	Press this key to enter the transient operation;
 key	Press this key to enter list data edit mode.

In the list operation menu, Select the function by ,  or  key, and select the data edition or data modification function by knob,  or . Then press dynamic  key to enter the list data edition menu as follows:

2016/08/08 10:23

Step	Mode	Value	A	Time
List:00	001	CCL	5.0000	5.0000 s
	002	CCL	0.0000	0.0000 s
	003	CCL	0.0000	0.0000 s
	004	CCL	0.0000	0.0000 s
	005	CCL	0.0000	0.0000 s

Esc H/L Prev Next

1.6.5 Basic Mode Menu & LCD Information





1.6.5.1 CC Mode Menu

Description: In Constant Current Mode, the load units will sink the amount of current programmed. Regardless of the voltage, the current will stay the same. For more details on CC Mode, please refer to Page 52.

2016/08/08 10:25

0.0000 V	0.0000 W
0.0000 A	CCH OFF
Para Set: 0.0000 A	RunTime: 00:00:00
Volt Start: 0.0000 V	RiseRate: 3.0000 A/us
Curr Limit: 150.00 A	FallRate: 15.000 A/us
Menu	H/L Tran List

Voltage Value	To display the current input terminal voltage;
Power Value	To display the current power value;
Current Value	To display the current value
Mode	CCH indicates constant current high range; CCL indicates constant current low range;





Input State	ON/OFF;
Run Time	To display the time the load being ON, reset when shutdown or switch mode;
Para Set	To set the constant current value, unit: A;
Volt Start	To set the start voltage of the load, 0 indicates the function being not enabled;
Current Limit	To limit the maximum Current level at the mode
Rising Rate	To control the current rising rate when starting
Falling Rate	To control the current falling rate when starting
 key	Press this dynamic key to return to the main menu;
 key	Press this key to switch between CCL and CCH;
 key	Press this key to enter the transient operation;
 key	Press this key to enter list data edit mode.

1.6.5.2 CR Mode Menu

Description: In Constant Resistance Mode, the load units will maintain a constant resistive load by varying the current. For more details on CR Mode, please refer to Page 57.







Voltage Value	To display the current input terminal voltage;
Power Value	To display the current power value;
Current Value	To display the current value

Mode	CRH indicates constant resistance high range; CRL indicates constant resistance low range;
Input State	ON/OFF;
Run Time	To display the time the load being ON, reset when shutdown or switch mode;
Para Set	To set the constant resistance value, unit:K Ω ;
Volt Start	To set the start voltage of the load, 0 indicates the function being not enabled;
Res Limit	To limit the minimum resistance level at the mode
RiseRate	To control the current rising rate when starting
FallRate	To control the current falling rate when starting
 key	Press this dynamic key to return to the main menu;
 key	Press this key to switch between CRL and CRH;
 key	Press this key to enter the transient operation;
 key	Press this key to enter list operation.

1.6.5.3 CV Mode Menu

Description: In Constant Voltage Mode, the load units will maintain a constant voltage value by varying the current. For more details on CV Mode, please refer to Page 54.







Voltage Value	To display the current input terminal voltage;
Power Value	To display the current power value;
Current Value	To display the current value
Mode	CVH indicates constant voltage high range; CVL indicates constant voltage low range;
Input State	ON/OFF;
Run Time	To display the time the load being ON, reset when shutdown or switch mode;
Para Set	To set the constant voltage value, unit: V;
Volt Start	To set the start voltage of the load, 0 indicates the function being not enabled;
Volt Limit	To limit the maximum voltage level at the mode
RiseRate	To control the voltage rising rate when starting
FallRate	To control the voltage falling rate when stopping
 key	Press this dynamic key to return to the main menu;
 key	Press this key to switch between CRL and CRH;
 key	Press this key to enter the transient operation;
 key	Press this key to enter list operation.

1.6.5.4 CP Mode Menu

Description: In Constant Power Mode, the load units will maintain a constant power by varying the current. For more details on CR Mode, please refer to Page 58.







Voltage Value	To display the current input terminal voltage;
Power Value	To display the current power value;
Current Value	To display the current value
Mode	CP indicates constant power mode;
Input State	ON/OFF;
Run Time	To display the time the load being ON, reset when shutdown or switch mode;
Para Set	To set the constant power value, unit: W;
Start Voltage	To set the start voltage of the load, 0 indicates the function being not enabled;
Pow Limit	To limit the minimum power level at the mode
RiseRate	To control the current rising rate when starting
FallRate	To control the current falling rate when stopping
 key	Press this dynamic key to return to the main menu;
 key	No function;
 key	Press this key to enter the transient operation;
 key	Press this key to enter list operation.

1.6.5.5 +CV Mode Menu

Description: +CV mode can be added to CC, CR and CP mode. For more details on +CV Mode, please refer to Page 60.



Voltage Value	To display the current input terminal voltage;
Power Value	To display the current power value;
Current Value	To display the current value
Mode	CCL indicates constant current low range; +CV indicates +constant voltage mode;
Input State	ON/OFF;
Run Time	To display the time the load being ON, reset when shutdown or switch mode;
Para Set	To set the constant current value, unit: A;
Volt Start	To set the start voltage of the load, 0 indicates the function being not enabled;
Curr Limit	To limit the maximum Current level at the mode
RiseRate	To control the current rising rate when starting
FallRate	To control the current falling rate when stopping
 key	Press this dynamic key to return to the main menu;
 key	Press this key to switch between CCL and CCH;
 key	Press this key to enter the transient operation;
 key	Press this key to enter list operation.

1.6.6 Error & Alarm Menu

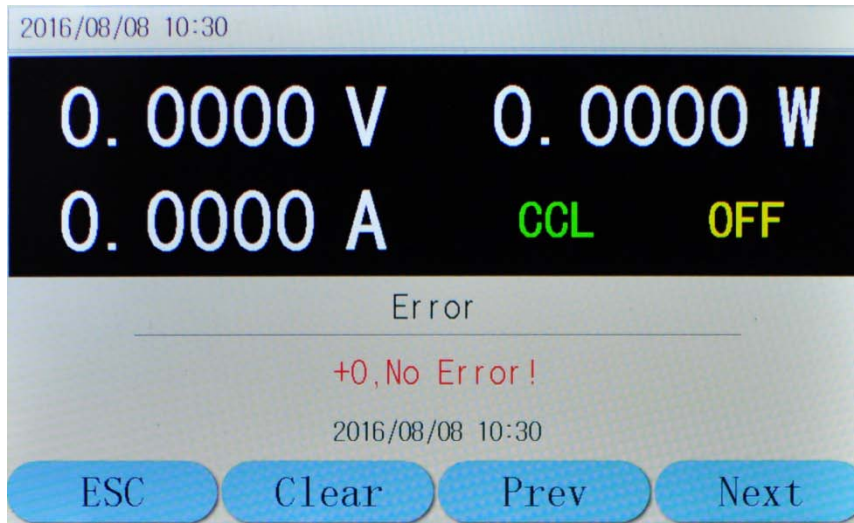

When the load appears **Alarm & Protection**, the LCD will display the corresponding alarm and protection state. The above diagram is the display of the reverse voltage protection.



The load has the following alarm functions: over current (OC), over voltage (OV), over power (OP), over temperature (OT), reverse voltage (RV);

And the load has the following protection functions: over current (OC), over power (OP), over temperature (OT).

1.6.7 Save Menu

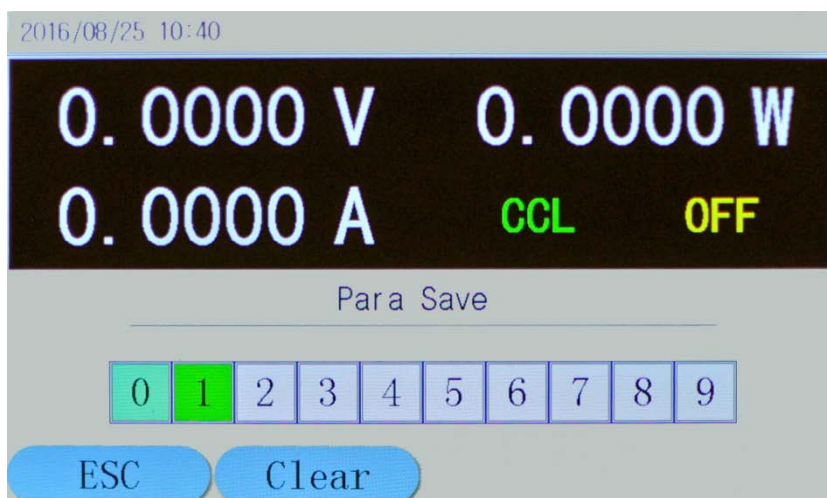

1.6.7.1 Application Save Menu



Storage Position	(0-9) totally 10
 key	Press this dynamic key to return to the main menu;
 key	Press this dynamic key to delete the data of the selected position.

1.6.7.2 Recall Save Menu



Storage Position	(0-9) totally 10
 key	Press this dynamic key to return to the main menu;
 key	Press this dynamic key to delete the data of the selected position.

1.7 Remote Programming

The commands are sent to the Eload via remote interface (RS232, GPIB or USB), decoded by the processor and then executed. If there is any error to the commands, the processor can detect the wrong command and the error type, and can maintain the status register as well.

Chapter II Functions and Features

This chapter will mainly introduce the functions and features of the load. After reading this chapter, you will have a better understanding of ARRAY 375XA Electronic Load.

2.1 Local & Remote Control

ARRAY 375XA Electronic Load can be controlled via the keypad and the knob in the front panel, or via the remote controller by the remote interface. If the load is needed to be controlled via the front panel, it has to be in local control status. The load will be in local control status automatically when it is powered on. When the load receives the remote commands: SYSTem:REMOte via the RS232, USB or GPIB, the LCD will display **Remote** status and the load will be turned in remote control status.

Under remote control status, all the operations of the keypads and knob (except **Local** key) are invalid. All operations on the load are controlled by remote controller. After receiving the return commands: SYSTem:LOCAl, the load will return to local control status and the **Remote** on the LCD will disappear. In remote control status, you can return the load to local control status via pressing **Local** key.

Details of local operation are covered in Chapter IV “Local Operation” and details of remote programming operation are covered in Chapter V “Remote programming Operation”. Complete programming details are given in 《ARRAY 375XA Electronic Load SCPI Programming Guide》.

2.2 Main Functions

The load can mainly work in the following modes:

- Constant Current Mode: CCL, CCH
- Constant Voltage Mode: CVL,CVH
- Constant Resistance Mode: CRL, CRH
- Constant Power Mode: CP
- Constant Current + Constant Voltage Mode: CCL+CV, CCH+CV

- Constant Resistance + Constant Voltage Mode: CRL+CV, CRH+CV
- Constant Power + Constant Voltage Mode: CP+CV
- Transient Operation: TRAN
- List Operation: LIST

2.3 Basic Test Functions





There are four basic test functions: constant current (CC), constant voltage (CV), constant resistance (CR), constant power (CP) and twelve operation mode: CCL, CCH, CVL, CVH, CRL, CRH, CP, CCL+CV, CCH+CV, CRL+CV, CRH+CV, CP+CV.

The operation mode and the relative parameters can be set via the front panel or the remote command. The load will remain in the current mode unless the user changes the settings. If the input of the load is in ON state, when the mode is changed, the load will be turned off automatically to avoid the potential impact of current.

The set value of the load will be effective immediately when the load is turned on. If the input set value exceeds the allowed range, it will be automatically limited at the maximum value or the minimum value.

2.3.1 CC Test

Constant current mode have two ranges: the high range (CCH) and the low range (CCL). The high range provides wider test range, while the low range provides better resolution at low current settings. In CC mode, the load will sink a constant current in accordance with the programmed value regardless of the change of input voltage. See Figure 2-1. In basic operation state, press

 key to select CCH or CCL constant current mode. Input the current value via number keys or knob combining with  and  keys. Then confirm the setting via  key. The CC operation mode and the parameters can be set via remote commands: MODE CCL | CCH

CURRent <NRf+>

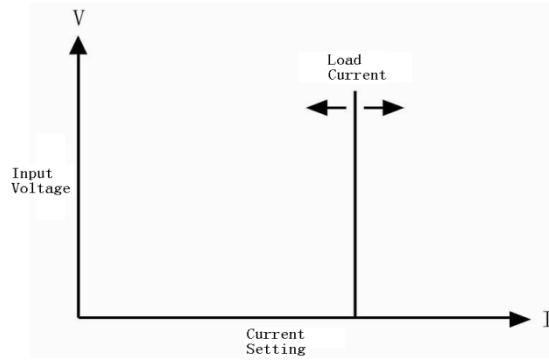

Figure 2-1 Constant Current Mode

2.3.1.1 Current Setting Range



The setting ranges for the load are listed as follows:

Model		3750A	3751A	3752A	3753A	3754A	3755A	3756A
Mode	CCL	0~6A	0~6A	0~6A	0~6A	0~8A	0~8A	0~8A
	CCH	0~100A	0~150A	0~75A	0~160A	0~180A	0~240A	0~260A

If the input of the load is ON, the load will be turned off automatically when the mode is changed.

For example: When the load is switched from CCL to CCH, the input of the load will be off automatically. Also of note is that the current set level may change with the current set mode and the changed value is the current value in current mode. For example: the original setting is CCH 150.000A. When the load is switched from CCH to CCL, the current set value will become the present current value 1A in CCL mode.

2.3.1.2 Immediate Current Level

The immediate current level is the current set value in CC mode, which can be set in parameter set menu in current mode, or can be set via remote command: `CRRRent<NRf+>`. In CC mode, the immediate current level can directly be modified via ,  or knob.

2.3.1.3 Triggered Current Level

The triggered current level is the preset current value in the load, which will become the

immediate current level automatically when a trigger is received. In CC mode, if the input of the load is ON, the input current will be updated immediately when a trigger occurs. If it is not in CC mode, the level will not affect the load until the CC mode becomes enabled.

The triggered current value can only be set via remote command: `CURRent:TRIGgered <NRf+>`. Once a triggered current level is triggered, the subsequent triggers will have no effect on the input unless another new triggering signal is sent. The trigger operation will be described in later chapter. The status register of the load can keep track of pending triggers and other operation conditions, which will be described in details in 《ARRAY 375XA Electronic Load SCPI Programming Guide》.

2.3.1.4 Transient Current Level

In transient current operation mode, the load can continuously toggle between the two levels: the transient level and the immediate level. The transient current level can be set in the transient operation menu or via the remote command: `CURRent: TLEVel <NRf+>`.

2.3.1.5 Software Current Level

The load allows the user to set a protection current level (the range is the same as that in CCH mode) via remote command. The load will be turned off with beeping alarms if the software current level is exceeded beyond a programmable time (0.001~60s). Please note that the protection current level is valid in any mode (not limited to CC mode) of operation. The remote commands are listed as follows:

`CURRent:PROTection <NRf+>`

`CURRent:PROTection:DELAy <NRf+>`

2.3.2 CV test

In CV mode, the load will attempt to sink enough current to control the source voltage to the programmed constant value regardless the change of the input current. See figure 2-2. In basic

operation state, select CVL or CVH mode via dynamic **H/L** key, then enter the voltage value via the keypads or knob combining with **◀** and **▶** keys, finally confirm the setting with **Enter** key. The CV mode and the parameters can also be set via the remote commands:

MODE CVL|CVH

VOLTage <NRf+>

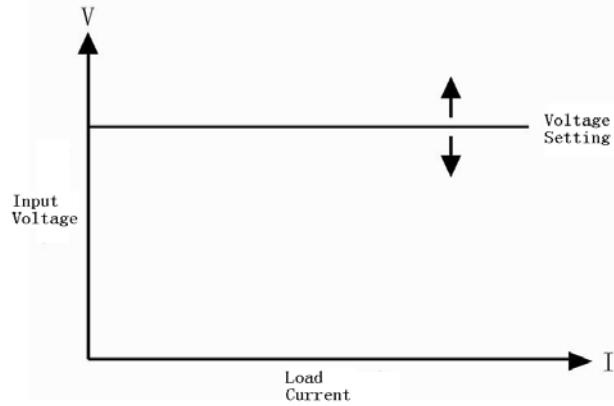

Fig. 2-2 CV Mode

2.3.2.1 Voltage Setting Range

The setting ranges of the voltage for the load are listed as follows

Model		375XA
Voltage	CVH	0~240V
	CVL	0~24V

2.3.2.2 Immediate Voltage Level

The immediate voltage level is the voltage set value in CV mode, which can be set in parameter set menu in voltage mode, or can be set via remote command: VOLTage<NRf+>. In CV mode, the immediate voltage level can directly be modified via **◀**, **▶** or knob.

2.3.2.3 Triggered Voltage Level

The triggered voltage level is the preset voltage value in the load, which will become the immediate voltage level automatically when a trigger is received. In CV mode, if the input of the load is ON, the input voltage will be updated immediately when a trigger occurs. If it is not in CV mode, the level will not affect the load until the CV mode becomes enabled.

The triggered voltage value can only be set via remote command: `VOLTage:TRIGgered <NRf+>`. Once a triggered voltage level is triggered, the subsequent triggers will have no effect on the input unless another new triggering signal is sent. The trigger operation will be described in later chapter. The status register of the load can keep track of pending triggers and other operation conditions, which will be described in details in 《ARRAY 375XA Electronic Load SCPI Programming Guide》.

2.3.2.4 Transient Voltage Level

In transient voltage operation mode, the load can continuously toggle between the two levels: the transient voltage level and the immediate voltage level. The transient current level can be set in the transient operation menu or via the remote command: `VOLTage:TLEVel <NRf+>`.

2.3.3 CR Test

There are two operation ranges: CRL and CRH in CR mode. In this mode, the electronic load is equivalent to a constant resistance, as shown in figure 2-3, and the electronic load will linearly change the current according to the input voltage to make $I=U/R$. In basic operation state, press

CR key to enter the mode and parameter set menu, select CR range via dynamic **H/L** key, then enter the resistance value via the keypads or knob combining with **◀** and **▶** keys, finally confirm the setting with **Enter** key. The CR mode and the parameters can also be set via the remote commands:

`MODE CRL | CRH`

`RESistance <NRf+>`

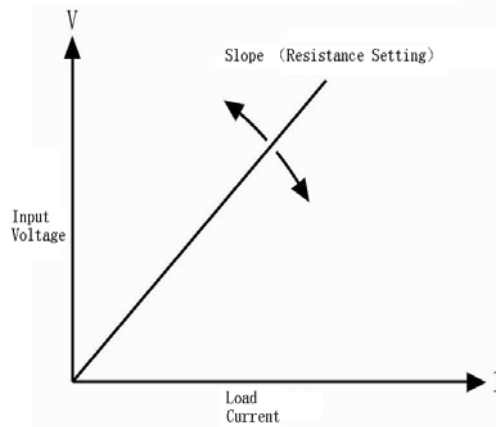

Fig. 2-3 Constant Resistance Mode

2.3.3.1 Resistance Setting Range



The setting ranges of the resistance for the load are listed as follows:

	Model	375XA
Mode	CRL	0.01Ω~240000Ω
	CRH	0.2Ω~2400KΩ

If the input of the load is ON, the load will be turned off automatically when the mode is changed. For example: When the load is switched from CRL to CRH, the input of the load will be off automatically. Also of note is that the voltage set level may change with the voltage set mode to be suitable for the new range. For example: the original setting is CRH 10.000Ω. When the load is switched from CRH to CRL, the voltage set value will become the minimum voltage value 0.0000Ω in CRL mode.

2.3.3.2 Immediate Resistance Level

The immediate resistance level is the resistance set value in CR mode, which can be set in parameter set menu in resistance mode, or can be set via remote command: RESistance <NRf+>.

In CR mode, the immediate resistance level can directly be modified via ,  or knob.

2.3.3.3 Triggered Resistance Level

The triggered resistance level is the preset resistance value in the load, which will become the

immediate resistance level automatically when a trigger is received. In CR mode, if the input of the load is ON, the input resistance value will be updated immediately when a trigger occurs. If it is not in CR mode, the level will not affect the load until the CR mode becomes enabled.

The triggered resistance level can only be set via remote command: RESistance:TRIGgered <NRf+>. Once a triggered resistance level is triggered, the subsequent triggers will have no effect on the input unless another new triggering signal is sent. The trigger operation will be described in later chapter. The status register of the load can keep track of pending triggers and other operation conditions, which will be described in details in 《ARRAY 375XA Electronic Load SCPI Programming Guide》.

2.3.3.4 Transient Resistance Level

In transient resistance operation mode, the load can continuously toggle between the two levels: the transient resistance level and the immediate resistance level. The transient resistance level can be set in the transient operation menu or via the remote command: RESistance: TLEVEL <NRf+>.

2.3.4 CP Test

The constant power mode is the constant power-voltage source mode, being suitable for the voltage source test. In CP mode, the load will consume a constant power from the power source regardless of the external current and voltage change to meet $U \cdot I = P$, as shown in figure 2-4. In basic operation state, press **CP** key to enter the mode and parameter set menu, then enter the power value via the keypads or knob combining with **◀** and **▶** keys, finally confirm the setting with **Enter** key. The CP mode and the parameters can also be set via the remote commands:

```
MODE CP
```

```
POWER <NRf+>
```

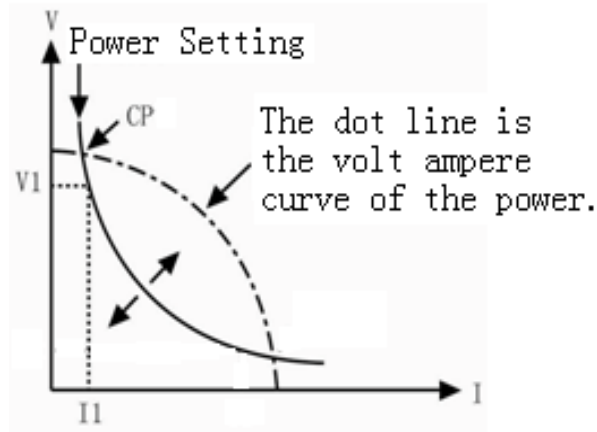



Fig. 2-4 Constant Power Mode

2.3.4.1 Power Setting Range

The setting ranges of the power for the load are listed as follows:

Model	3750A	3751A	3752A	3753A	3754A	3755A	3756A
Power	0~1500W	0~2000W	0~1000W	0~2400W	0~3000W	0~4000W	0~5000W

2.3.4.2 Immediate Power Level

The immediate power level is the power set value in CP mode, which can be set in parameter set menu in power mode, or can be set via remote command: `POWER <NRf+>`. In CP mode, the immediate power level can directly be modified via ,  or knob.

2.3.4.3 Triggered Power Level

The triggered power level is the preset power value in the load, which will become the immediate power level automatically when a trigger is received. In CP mode, if the input of the load is ON, the input power value will be updated immediately when a trigger occurs. If it is not in CP mode, the level will not affect the load until the CP mode becomes enabled.

The triggered power value can only be set via remote command: `POWER:TRIGgered <NRf+>`.

Once a triggered power level is triggered, the subsequent triggers will have no effect on the input unless another new triggering signal is sent. The trigger operation will be described in later chapter.

The status register of the load can keep track of pending triggers and other operation conditions, which will be described in details in 《ARRAY 375XA Electronic Load Programming Guide》.

2.3.5 CC+CV Test

When CC+CV mode is enabled, if the input voltage is more than the limit voltage, no matter how the input current is changed, the Eload will always enter the voltage at the limit of the voltage. If the input voltage is less than the limit voltage, no matter how the input voltage changes, the input current of the Eload will be always at the setting current.

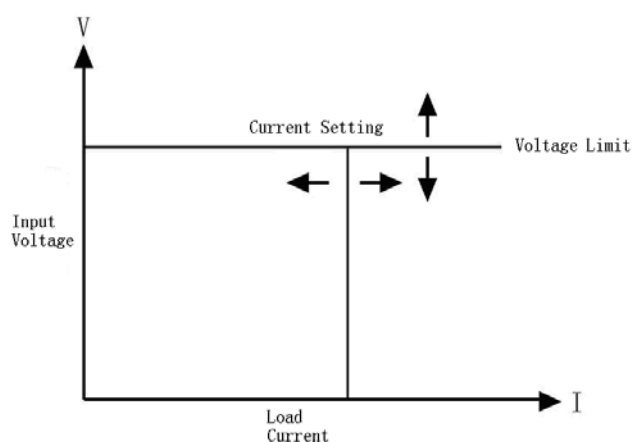

2.3.6 CR+CV Test

When CR+CV mode is enabled, if the input voltage is more than the limit voltage, no matter how the input current is changed, the Eload will always enter the voltage at the limit of the voltage. If the input voltage is less than the limit voltage, no matter how the input voltage changes, the resistance of the Eload will be always at the setting resistance.

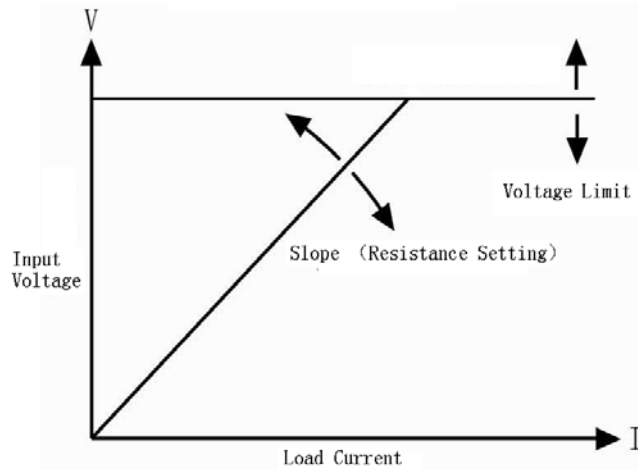

2.3.7 CP+CV Test

When CP+CV mode is enabled, if the input voltage is more than the limit voltage, no matter how the input current is changed, the Eload will always enter the voltage at the limit of the voltage. If the input voltage is less than the limit voltage, no matter how the input voltage changes, the power of the Eload will be always at the setting power.

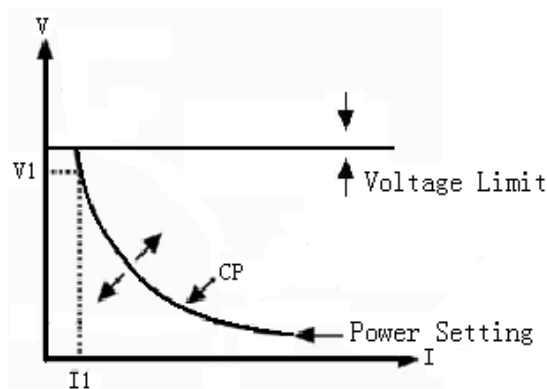

2.4 Transient Operation

In transient operation mode, the load can continuously toggle between the two levels: the transient high level (LevelH) and the transient low level (LevelL), which can be applied to test the dynamic features of the power source. The transient operation can be executed in CC, CV, CR and CP mode and there are three operation statuses: Continuous, Pulse and Toggle. Please make sure that the List Operation function has been turned off before the transient operation.

The transient operation parameters include: transient low level (LevelL), transient high level

(LevelH), low level time (TimeL), high level time (TimeH), time for rising edge (TimeR), time for falling edge (TimeF) and operation mode.

The transient high/low level and the corresponding CC, CV, CR and CP modes share the same setting ranges.

The range for high/low level time is 10us~10s; the range for rising/falling edge time is 10us~10s; the time resolution is 10us and the maximum test frequency is 50kHz.

The transient operation can be turned on and off via the dynamic  key on the front panel or the remote command: SYSTem:STATe TRANsient.

Notes: In transient operation, the VON voltage, the protection current and so on parameter should be considerate. The improper parameter setting may cause the shut down of the input and thus interrupt the transient operation.

2.4.1 Continuous Transient Operation

In continuous transient operation, the load periodically toggles between the high/low levels. This operation is not affected via the trigger signal. The relevant parameters, such as transient low level (LevelL), transient high level (LevelH), low level time (TimeL), high level time (TimeH), time for rising edge (TimeR), time for falling edge (TimeF) and operation mode, can be set in transient operation menu or via the followed remote command:

```

SYSTem:STATe TRANsient      // enter the transient operation mode

CURRent <NRf+>              // transient low level

CURRent: TLEVel<NRf+>      // transient high level

VOLTage <NRf+>

VOLTage: TLEVel<NRf+>

RESistance <NRf+>

RESistance: TLEVel <NRf+>

TRANsient:LTIME <NRf+>

TRANsient:HTIME <NRf+>

TRANsient:RTIME <NRf+>

TRANsient:FTIME <NRf+>

```

TRANsient:MODE CONTInuous

For Example: assume that the CCH range is active, the input of the load is OFF, then the transient parameters should be set as follows:

Press dynamic  key to enter into transient operation;

Set the following parameters listed in transient operation menu:

LevelL: 5.000A

LevelH: 10.000A

TimeL: 0.00050s

TimeH: 0.00050s

TimeR: 0.00020s

TimeF: 0.00020s

Mode: Cont

Then press  key to turn on the input;

Or via remote command to set:

SCPI Command	Description
SYST:STAT TRAN	To enter into transient operation mode;
CURR 5	To set the transient current low level to 5A;
CURR: TLEVEL 10	To set the transient current high level to 10A;
TRAN:LTIM 0.0005	To set the transient low level time to 0.00050s;
TRAN:HTIM 0.0005	To set the transient high level time to 0.00050s;
TRAN:RTIM 0.0002	To set the time for transient rising edge to 0.00020s;
TRAN:FTIM 0.0002	To set the time for transient falling edge to 0.00020s;
TRAN:MODE CONT	To select continuous operation;
INP ON	To turn on the input of the load.

The followed Figure 2-6 show the current waveform of the load: after 200us duration of rising edge, the load's input current reaches the transient high level (10A) and remain at 10A for 500us. Then after 200us duration of falling edge, the input current reaches the transient low level (5A) and remains at 2A for 500us. Repeat it in cycles.

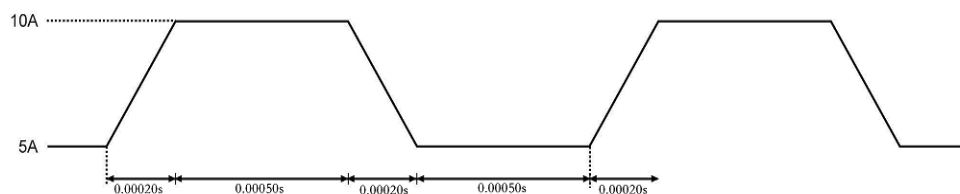

Figure 2-6 Continuous Transient Operation

2.4.2 Pulsed Transient Operation

The trigger function is required for pulsed transient operation. When there is no trigger occurs, the load remains at the transient low level. After a trigger has been received, a pulse, which is with three stages: rising edge, transient high level and falling edge, will appear. Then the load returns to the transient low level again. The associated parameters such as transient low level (LevelL), transient high level (LevelH), high level time (TimeH), low level time (TimeL), time for rising edge (TimeR), time for falling edge (TimeF) and pulsed transient mode can be set through transient operation menu or via the followed remote command.

```

SYSTEM:STATe TRANSient      // enter the transient operation mode
CURRENT <NRf+>               // transient low level
CURRENT: TLEVel <NRf+>      // transient high level
VOLTage <NRf+>               // voltage at transient low level
VOLTage: TLEVel <NRf+>      // voltage at transient high level
RESistance <NRf+>            // resistance at transient low level
RESistance: TLEVel <NRf+>    // time for transient low level
TRANSient:HTIME <NRf+>      // time for transient high level
TRANSient:RTIME <NRf+>      // time for transient rising edge
TRANSient:FTIME <NRf+>      // time for transient falling edge
TRANSient:MODE PULSe        // transient operation mode

```

In order to get a pulse, an explicit trigger is required. The trigger can be produced by the signal from the external trigger terminal, or via the remote command *TRG. The trigger is effective only when the load remains at transient low level. Each trigger leads to one pulse. In the duration of the whole rising edge, transient high level and falling edge, any trigger will be ignored. It is need to

do the trigger initial operation before the trigger operation, otherwise the load won't response to the trigger.

For example: assume that the CCH range is active, and the input of the load is OFF, then the transient parameters should be set as follows:

Press dynamic key  to enter into transient operation interface;

Set the following parameters in the transient operation menu:

LevelL: 5.000A

LevelH: 10.000A

TimeH: 0.50ms

TimeR: 0.10ms

TimeF: 0.10ms

Mode: Puls

Then press  key to turn on the input;

Send the trigger initial command to the load: INIT;

Or set via the remote programming interface:

SCPI Command	Description
TRIG:SOUR EXT	To select the external trigger input;
SYSTem:STATe TRANSient	To enter the transient operation;
CURR 5	To set the transient current low level to 5A;
CURR: TLeVel 10	To set the transient current high level to 10A;
TRAN:HTIM 0.0005	To set the transient high level time to 500us;
TRAN:RTIM 0.0001	To set the time for transient rising edge to 100us;
TRAN:FTIM 0.0002	To set the time for transient falling edge to 100us;
TRAN:MODE PULS	To set the pulsed operation mode;
INP ON	To open the input of the load;
INIT	The initial operation before trigger

Get the trigger by receiving an external trigger signal. Figure 2-7 shows the current waveform of the load in pulse transient operation before and after being triggered. After the input of the load is ON, the load starts its operation at the transient low level (5A). For each trigger, after 10 us duration of rising edge, the load current reaches the high level (10A) and remains at 10A for 500us.

Then after 200 μ s duration of falling edge, the current returns to the transient low level (5A).

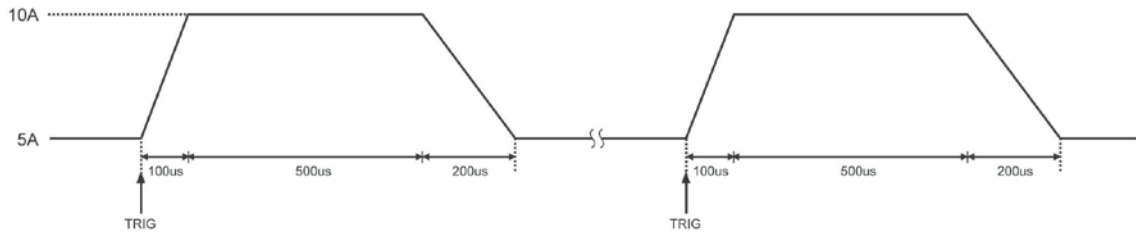

Fig. 2-7 Pulsed Transient Operation

2.4.3 Toggled Transient Operation

The trigger function is required for toggled transient operation. When there is no trigger occurs, the load remains at the transient level. After a trigger has been received, a toggle operation will be executed and the other transient level will be reached after the duration of the rising edge or the falling edge. The associated parameters such as transient low level (LevelL), transient high level (LevelH), transient high level (LevelH), time for rising edge (TimeR), time for falling edge (TimeF) and toggled transient mode can be set through transient operation menu or via the followed remote command:

CURRent <NRf+>	To set the transient current low level;
CURRent:TLEVel <NRf+>	To set the transient current high level;
VOLTage <NRf+>	To set the transient voltage low level;
VOLTage:TLEVel <NRf+>	To set the transient voltage high level;
RESistance <NRf+>	To set the transient resistance low level;
RESistance:TLEVel<NRf+>	To set the transient resistance high level;
TRANsient:RTIME <NRf+>	To set the time for transient rising edge;
TRANsient:FTIME <NRf+>	To set the time for transient falling edge;
TRANsient:MODE TOGGLE	To set the toggled operation mode;

The trigger can be produced by the signal from the external trigger terminal, or via the remote command *TRG. It is need to do the trigger initial operation before the trigger operation, otherwise the load won't response to the trigger.

For example: assume that the CCH range is active, and the input of the load is OFF, then the

transient parameters should be set as follows:

Press dynamic key  to enter into transient operation interface;

Set the following parameters in the transient operation menu:

LevelL: 5.000A

LevelH: 10.000A

TimeR: 0.10ms

TimeF: 0.20ms

Mode: Togg

Then press  key to open the input of the load;

Send the trigger initial command to the load: INIT;

Or set via the remote programming interface:

SCPI Command	Description
TRIG:SOUR EXT	To select the external trigger input;
SYSTem:STATe TRANsient	// To enter the transient operation mode;
CURR 5	To set the transient current low level to 5A;
CURR:TLEVel 10	To set the transient current high level to 10A;
TRAN:RTIM 0.0001	To set the time for transient rising edge to 100us;
TRAN:FTIM 0.0002	To set the time for transient falling edge to 200us;
TRAN:MODE TOGG	To select toggled operation mode;
INP ON	To turn on the input;
INIT	The initial operation before trigger

Get the trigger by receiving an external trigger signal. Figure 2-8 shows the current waveform of the load before and after being triggered. After the input of the load is ON, the load starts its operation at the transient low level (5A). For the first trigger, after 10 us duration of rising edge, the load current reaches the high level (10A) and remains at 10A. When the second trigger is received and after 200us duration of falling edge, the current returns to the transient low level (5A) and remains at 5A. In toggled transient operation, the load will switch between the transient low level and the transient high level when receiving a triggering signal and repeated the toggle in cycle.

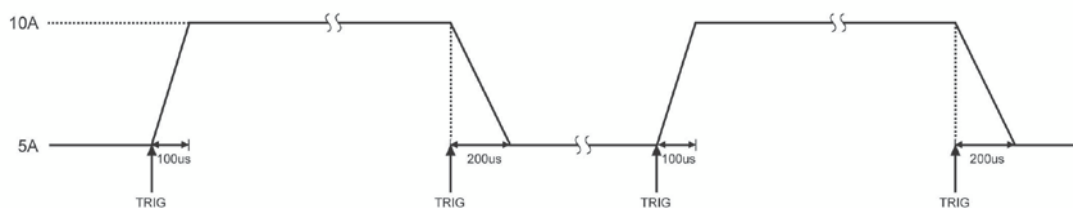

Figure 2-8 Toggled Transient Operation

2.5 List Operation

Beside the transient operation, the load provides more flexible list operation, which can make the load operate according to the preset sequence.

The list operation allows the users to program series of sequence steps and the operation mode, load's value, the duration time for each step can be set. The sequence operation can be executed in the CV, CC , CR and CP modes. The minimum time duration for each step is 10us and the maximum one is 99999s (about 27.78 hours). The list operation allows to be executed cyclically and the cycle time can be set. And different list operations can be chained. After the execution of one list operation, another list operation will be enabled via the chained connection, expanding the capacity of the list operation and implementing more complicated test task. The load can store 10 lists, which can contain 50 steps at most.

The associated parameters of the list operation can be edited and set through list operation menu or via remote command. The load provides convenient list editing function. When the user is inputting or editing the sequence step, it is easy to check the previous and subsequent steps, and it is allowed to be modified and deleted, which effectively simplifies the list input operation.

The set value of each step will be saved automatically when exiting from step edit menu. And the other list parameters will be saved immediately after being edited.

The list operation also can be implemented via the remote command.

Please make sure that the transient operation is OFF before enabling the list operation. Figure 2-9 is a list running diagram of a 5-steps list operation. See Chapter IV 4.8 List Operation for details.

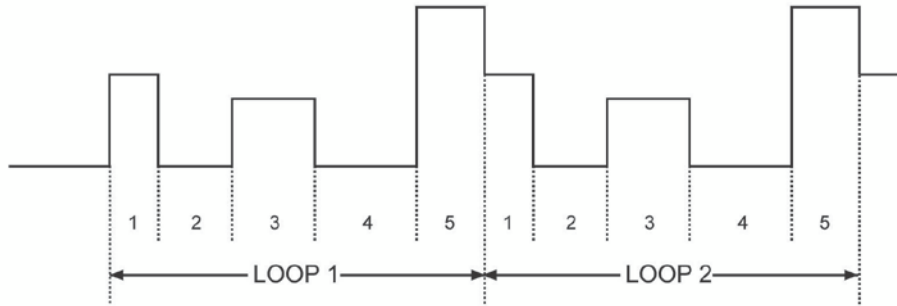

Figure 2-9 List Operation

Notes: In list operation, the Von point and the current limit level should be taken into consideration, which may cause the shut down of the input, thus interrupt the list operation.

2.6 Triggered Operation

The triggered operation is mainly used to keep the load synchronized with other test equipments or events. The load provides various triggering modes, which can be applied in the following occasions:

- **Triggering a preset level**

Transfer all pending preset levels to the immediate levels. For the present active mode, the new level will appear at the input terminal immediately if the input of the load is on. For other modes, the preset levels will not be effective at the input terminal until the corresponding mode is active.

- **Triggering a transient pulse**

In pulse transient operation, the trigger will generate a transient pulse in accordance with the present transient parameters.

- **Triggering a transient toggle**

In toggle transient operation, the trigger will make the load switch once between the transient low level and the transient high level as the preset transient parameters.

- **Triggering a list operation**

In list operation, the trigger will enable the load to start the present list operation.

Three triggering methods are available for remote control: GPIB <GET> signal, the *TRG command and the TRIGger command. The external trigger input terminal on the front panel can also be used to trigger as well.







The load has three triggering sources: BUS, EXTERNAL and HOLD.

- **The BUS mode:** GPIB <GET> signal or the *TRG command is the trigger source.
- **The EXTERNAL Mode:** Choose the trigger input terminal of the load as the trigger source. The input signal at the external trigger input terminal is TTL, and the falling edge signal is triggered.
- **The HOLD:** Only the remote command TRIGGER[:IMMEDIATE] can be used as the trigger source. At this time, all other triggering sources including *TRG become invalid.

Notes: The TRIGGER:IMMEDIATE command can be used in all three triggering modes. The triggering sources can only be selected via the remote command TRIGGER:SOURCE BUS | EXTERNAL | HOLD. Please do the trigger initial operation to the load before triggering operation, otherwise any trigger will be ignored.

2.7 Input Control

2.7.1 ON/OFF of ELoad Input

The input of the load can be turned on/off via  key, or via the remote command: INPUT ON | OFF. If the load's input is in OFF state, press  key to turn on the input, and the yellow indicator  turns to green , and the LCD displays ON. If the load's input is in ON state, press  key to turn off the input, and the green indicator  turns to yellow . Turning on/off the input does not affect the programmed settings.

In local control, if the input is ON, the load's state can not be switched directly among the basic modes, the transient operation, the list operation and so on states. When the load switches from one operation to another operation, the load will be turn off automatically.

2.7.2 Von Point/Von Latch

When the external input voltage is lower than the Volt Start Point, the load will not be able even though the input is ON. Only when the external input voltage reaches or exceeds the Von Point, the load will start to work. The default Von Point is 0V.

Von Latch is used to latch the active status of the load. The Volt Start Point being 0V means the Volt Start Latch function being inactive. If the Volt Start Latch function is needed to be enabled, it is only need to adjust the Volt Start voltage to the desired set level. When the input voltage reaches the Volt Start value, the load's input state is ON. When the input voltage under the Volt Start value, the load's input state is OFF. As in figure 2-11, when the Volt Start Point is 0, the function is disabled. Via setting the Volt Start Point and the Volt Start Latch, the input of the load can be turned on/off automatically, which greatly simplifies the test operation.

The Volt Start Point can be set in main menu, or via remote command: `VOLTage:STARt <NRf+>`.

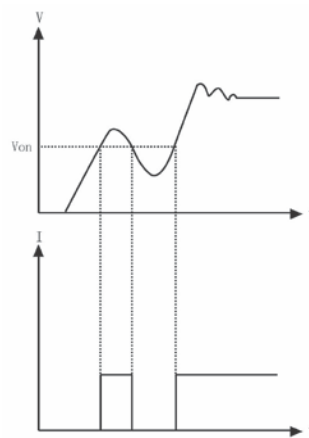

Fig. 2-11 Von Point

2.7.3 Current Limit Function in CV Mode

The current limit function is to limit the maximum set current of the load in CC, CR and CP modes. If the set current reaches or exceeds the set current level, the load will switch to the CC mode and run at the limit current, thus to realize limiting the maximum running current as in Fig. 2-13.

The current limit function can be set via the remote command: `INPut:LIMit:CURRent <NRf+>`.

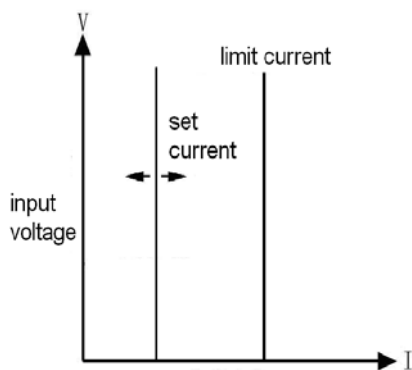

Fig. 2-13 Current Limit Function in CV Mode

2.7.4 Current Rising Rate

Curr Rise Rate is to set the current rising rate in CC, CV and CP modes. It can be set in the main menu or via the remote command: `CURRENT:SLEWrate:POSitive <NRf+>`.

If the current rising rate is $0.1\text{A}/\mu\text{s}$, and the current set level is 20A , then the current rising rate diagram is shown as in Figure 2-14 when the input is turned on:

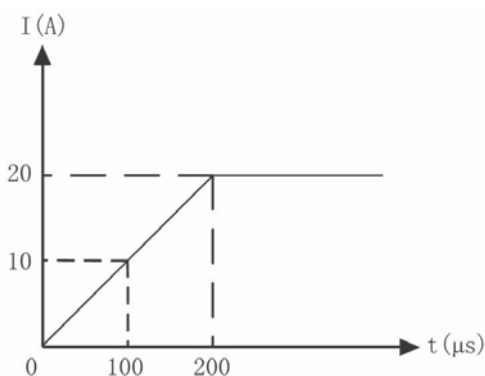

Fig. 2-14 Current Rising Rate

2.7.5 Current Falling Rate

Curr Fall Rate is to set the current falling rate in CC mode. It can be set in the main menu or via the remote command: `CURRENT:SLEWrate:NEGative <NRf+>`.

If the current falling rate is $0.1\text{A}/\mu\text{s}$, and the current set level is 20A , then the current falling rate diagram is shown as in Figure 2-15 when the input is turned off:

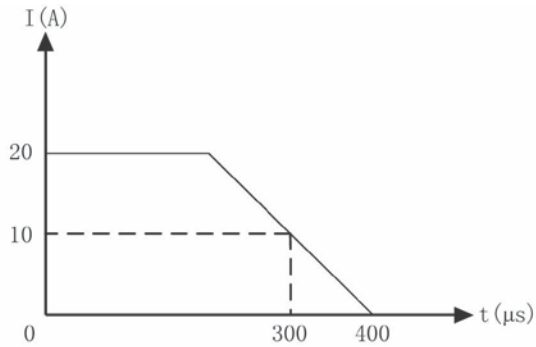

Fig. 2-15 Current Falling Rate

2.8 Measurement Function

The load has high resolution measurement function, which can measure the voltage and the current in realtime. The input power level and the resistance level can be computed with the input voltage level and the current level. The measured level can be checked through LCD display directly or be read via the remote commands:

MEASure:VOLTage?;

MEASure:CURREnt?;

MEASure:RESistance?;

MEASure:POWer?

2.9 Saving and Recalling

The load has EEPROM memory, which can be used to save various parameters, such as modes, input status, current, voltage, resistance, transient settings, protection levels, etc. The 375XA electronic load can save 10 groups of parameters. All parameters relevant to saving and recalling operation are listed in Table 2-1 (Take 3751A as an example.).

Table 2-1

Function	Effect	Default
Input	Input Status	Off
Mode	Operation Mode	CCH
Current	Immediate Current Level	0A

Current Rise Rate	Current Rising Rate	15A/us
Current Fall Rate	Current Falling Rate	15A/us
Current TLEVel	Transient Current Level	0A
*Current Protection Level	Current Protection Limit	150A
*Current Protection Delay	Current Protection Delay	60s
*Current Protection State	Enable/Disable Current Protection	Off
Voltage	Immediate Voltage Level	240v
CV Current Limit	Current Limit in CV mode	150A
Voltage TLEVel	Transient Voltage Level	240v
Resistance	Immediate Resistance Level	2000Ω
Resistance TLEVel	Transient Resistance Level	2000Ω
Power level	Immediate Power Level	0W
Transient Operation	Transient Test	Off
Transient Mode	Transient Mode	Continuous
Transient Htime	Time for Transient High Level	0.00001s
Transient Ltime	Time for Transient Low Level	0.00001s
Transient Rtime	Time for Transient Rising Edge	0.00001s
Transient Ftime	Time for Transient Falling Edge	0.00001s
*Trigger Source	Trigger Source	External
Latch Voltage Level	Von Point of the Load	0V

*** indicates that it can only be programmed in the remote control.**

There are 10 groups of parameters stored in Position 0~9, which can be saved and recalled by pressing **Save** key and **Call** key, or via the remote command: *SAV < NRI > and *RCL < NRI >.

The parameters saved in Position 0 will be recalled automatically every time the load being turned on.

2.10 Read Remote Program Errors

The Err annunciator at the upper right corner on the screen will display the error information when the remote programming errors occur. The error codes are shown as follows:

- -1xx Command errors
- -2xx Execution errors
- -3xx Device-specific errors
- -4xx Query errors
- The remote programming errors can be checked in the error code interface by pressing ERROR key on the front panel or via remote query command: `SYSTEM:ERROR?`.

All the error messages are saved in one error queue, which is a first-in first-out structure buffer and in which 20 pieces of error messages can be saved. If the error messages exceed 20 the last error in the error queue will be replaced with -350, "Too many errors". At this time the load will not save any additional error message, unless the error messages are read or deleted. Once the error message is read, it will be deleted from the error queue.

2.11 Status Report

The load has a status reporting register, from which various status conditions of the load can be queried. The user can confirm which events will be reported through setting the enable register in the status register group. The registers will be introduced in details in 《ARRAY 375XA Electronic Load SCPI Programming Guide》.

2.12 Protect and Alarm Function

Load has the following alarm functions:

- Over voltage (OV)
- Reverse voltage Protection (RV)

Load has the following alarm and protection functions:

- Over Current (OC)
- Over Power (OP)
- Over Temperature (OT)

If the load goes wrong, the input will be shut down with beeps, and the LCD will display the detected conditions and the load will enter into the latched protection status. And the corresponding state bit in the register will be set. Except some specific operations, the load will not respond to other commands. For example: If an overtemperature condition has been detected, the input will be turned off with beeps. And the OT will be shown in the lower right corner of the LCD and the load will have no response to other operation commands.

2.12.1 Clearing Latched Function

When the load enters the latched protection state, it will not respond to any other commands. It will return to normal operation only after clearing the latched protection via compound keys **Shift** and **Esc**, or via the remote command: INPut:PROTection:CLEAr. Of course the condition that cause the latch protection must be cleared, otherwise it will cause the latched protection again immediately.

In addition, when the software current protection function is enabled, if the overcurrent time does not exceed the set protection time, the load will display PT to indicate, but the input will not be turned off. At this time, user can reset the overcurrent time via compound keys **Shift** and **Esc**, or via the remote command: INPut:PROTection:CLEAr.

2.12.2 Overvoltage

The overvoltage alarm level is set at a predetermined voltage, which cannot be changed by the user. When the voltage exceeds this predetermined voltage, the overvoltage protection will be enabled, and the input is turned off with OV display. Meantime, the OV and VF status register bits are set and remain until they are reset and the overvoltage condition is removed.

2.12.3 Overcurrent

The load allows the user to define a current protection limit. When the defined current limit is exceeded, the input will not be turned off immediately but the overcurrent timer will start to time, and the display will show PT to indicate the protection status. When the specified delay time is

reached, the current protection is triggered, the input will be turned off and the display will show OC. Meantime, the OC and PS status register bits are set and remain until they are reset and the overcurrent condition is removed.

The current protection limit function can only be set via following remote commands:

SCPI Command	Description
CURRent:PROTection:STATe ON OFF	To turn on/off the current protection limit function
CURRent:PROTection < NRf+>	To set the current limit level
CURRent:PROTection:DELAy < NRf+>	To set the delay time to turn off the input

2.12.4 Overpower

The load has both hardware and software overpower protection function.

Once the input power exceeds the rated maximum power, the hardware power-limit circuit will be enabled immediately to limit the input power within the allowed range and send the overpower alarm. Meantime, the load will compute the present actual power. No matter the hardware power limit circuit is enabled or the software test and compute, when the overpower time exceeds 10S, the overpower protection will be triggered.

When the overpower protection is enabled, the display shows OP and the buzzer sends alarm. Meantime, the OP and PS status register bits are set and remain until they are reset and the overpower condition is removed.

2.12.5 Overtemperature

If the internal temperature of the load is over the safe limit, the overtemperature protection will be triggered and enabled. The input will be turned off with OT displayed. Meantime, the OT and PS status register bits are set and remain until they are reset and the overtemperature condition is removed. In clearing latched function state, it will have to wait till the load cools down to the normal temperature. When OT alarm appears, please do not turn off the power, the fans in the load will help to cool the temperature in the load.

2.12.6 Reverse Polarity

In case the input DC voltage lines are connected with wrong polarity, the reverse polarity alarm function will be triggered. The input of the load will be turned off with RV display. Meantime, the RV and VF status register bits are set and remain until they are reset and the reverse polarity condition is removed.

Chapter III Installation

3.1 Initial Check

After receiving the load, please check if there is any obvious damage that may have occurred during the shipment. Please keep the original packing materials in case the load has to be returned to ARRAY in future.

Please confirm that there is no breakage on the keys and knob, that the cabinet and panel surfaces are free of dents and scratches, and that there is no scratch or crack on the LCD display.

Packing List

1	Main Machine	1
2	Terminal Accessory	2
3	Main Power Cable (region dependent)	1
4	USB Cable	1
5	RS232C Cable	1
6	CD-ROM (User's manual/Programming Manual)	1
7	Calibration Report	1

3.2 Environment/Installation Location

The load can run at its' full power within the temperature range of 0°C to 40°C, and at a decreased power from 40°C to 50°C, otherwise the overtemperature protection will be caused.

Place the load in a location with good ventilation, and keep a distance from the electromagnetic interference. Do not place the load in the flammable atmosphere.

When being installed in the mounting rack, the space is limited to the height of 4U. The four pads must be removed. The load must be installed in a location that allows sufficient space in the front and at the back of the load for adequate air circulation. When load working, the fans cool the load by drawing in air from the front and exhausting out from the back.

3.3 PowerOn/Self-check

A power-on self-test can inspect the basic operations of the load as a preliminary test method for the load acceptance.

Before powering on the load, please check the AC power-line voltage to make sure that the voltage of the Toggle Key on the rear panel is the same with the local power supply voltage.

A power-on self-test will occur automatically after connecting the power-line cord and pressing the Power Switch (as in the following diagram) on the front panel.

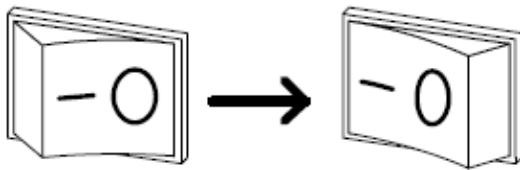

If the unit fails to start up properly or does not turn on, please contact the supplier.

If the load detects an error during the power-on self-test, the error messages will be displayed. The error messages are as shown in the followings:

Error Code	Error Explanation
601	LCD self-test error
603	System ADC test failed
607	Rundown too noisy
608	Keypad self-test error
609	EEPROM checksum failed
630	Temperature test failed

If there is no error being detected, it will enter CCL mode interface as default and the input of the load is OFF. Then power on the load and execute the following test after thirty-minutes warm up.

Connect the output of a power supply, which is with CV and CC mode, to the load's input with correct polarity to execute CCH 5A and CV 5V operations. If the load runs normally, it will draw the current of 5A or regulate the input voltage to 5V within the allowed tolerance specified in this manual. Thus it can be concluded that the basic work of the load is normal.

3.4 Connection of the Rear Panel

The rear panel of 375XA Electronic Load is shown as Fig. 3-1, which mainly includes test input parts, AC input parts and communication interface parts. The AC input parts include AC input socket, the fuse holder and the voltage toggle key. The communication interface parts include RS-232 interface, USB interface and the optional GPIB expansion interface.

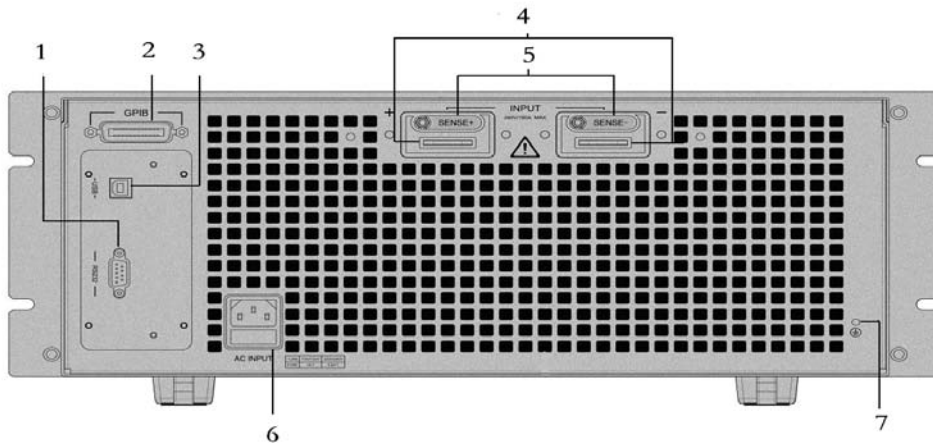

1. GPIB input socket (Optional)
2. USB input socket
3. RS232C input socket
4. Input terminal, Input (+,-) to connect the being tested components
5. Voltage test terminal, Remote sense(+,-) the connecting port for remote test
6. AC input socket, fuse holder, the voltage toggle key
7. Earthing terminal to connect the system to the earth in rack mounting

1. AC Power Socket, Fuse Holder

AC power cable type needs to meet the local standard of us;

Fuse Specifications: 250V T1A;

Voltage toggle key can select 110V, 120V, 220V and 240V. The selected voltage should be in accordance with the power voltage in local place.

2. Input Terminal

There are two large copper terminals (INPUT+, INPUT-) on the rear panel, for the input connection and the maximum diameter of the wire is 6mm. To improve the accuracy of the test

and reduce the measurement error, a thick cable is suggested to use in a large current test.

3. Remote Voltage Test Terminal

There are two remote voltage test terminals (SENSE+, SENSE-) one the rear panel, for the remote voltage test to prevent the affect on the voltage test of the voltage drop of the load input wiring and to improve the accuracy of the voltage measurement. ARRAY 375XA Electronic Load can detect the remote voltage input signal automatically, and it is unnecessary to modify the parameter settings or change the hardware wiring in remote voltage test.

4. Communication Interfaces

RS-232 interface

The load provides an RS-232 interface, which is a standard DB9 pin connector, and uses the DTR and DSR signals for flow control. The RS-232 Connector Pins is as below:

Pin	Input/Output	Description
1	-	No connection
2	Input	RXD, receive data
3	Output	TXD, transmit data
4	-	No connection
5	Common	GND, signal ground
6	-	No connection
7	-	No connection
8	-	No connection
9	-	No connection

The interface parameters can be set in the Com Port Configuration Menu as in the following diagram, and you can use SCPI language for programming to realize the communication with the load.



GPB interface

The load provides a GPB interface, whose address can be set in the range from 0 to 30 in the port configuration menu. When multiple GPB devices are connected, the address of the GPB for each device should be unique and cannot be used by other devices on the BUS. The factory default address of the load is set to 05.

USB interface

User needs to install the corresponding software in PC to communicate with the load.

5. Earthing Terminal

Connect the system to the earth in rack mounting.

3.5 Connection on the Front Panel

The connection terminals of 375XA electronic load on the front panel include the external trigger input terminal and the current monitoring output terminal, as shown in Fig. 3-2.

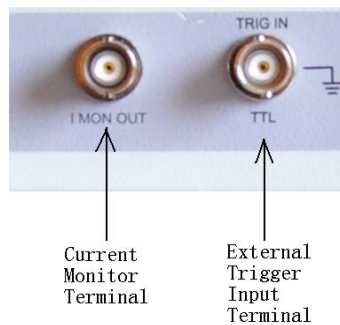

Fig. 3-2

1. The external trigger input terminal is a BNC connecting terminal, in which the middle part is input + and the outer case is the input-. It receives 5V TTL-compatible falling-edge trigger signals. In order to get a reliable trigger, the duration time of low level hold be longer than 10us.
2. The current monitoring output terminal: when connecting the oscilloscope, it can monitor the realtime state of the current (The terminal and the communication terminal share the common ground, and the terminal has the insulation voltage 3000VAC with the load input terminal.).

3.6 Wiring

Description: The rear panel input terminals accept up to M8-sized crimped terminal and equipped with a pairs of lugs.

Procedures:

1. Turn off the power;
2. Turn off the DUT power;
3. Connect the load wires to the input terminal:

Connect the positive (+) terminal on the load module to the high potential output of the DUT.

Connect the negative (-) terminal on the load module to the low potential output of the DUT.

Wiring

Wire Gauge (AWG): Before connecting the unit to the power source, the wire gauge must be taken into account. The load wires must be large enough to resist the overheating when a short-circuit condition occurs as well as to maintain a good regulation. The size, polarity and length of a wire are all factors in determining if a wire will withstand short circuit. Wires that are selected must be large enough to withstand a short circuit and limit voltage drops to no more than 1V per wire. Use the table below to help make a suitable selection.

Load wiring AWG table:

AWG Gauge	Diameter (Unit: mm)	Ohms Per km(Ω /km)	Max Amps for Classis wiring

0000	11.684	0.16072	380
00	10.4038	0.2027	328
00	9.26529	0.25551	283
0	8.25246	0.32242	245
1	7.34822	0.40639	211
2	6.54304	0.51266	181
3	5.82676	0.64616	158
4	5.18922	0.81508	135
5	4.62026	1.02762	118
6	4.1148	1.29593	101
7	3.66522	1.6341	89
8	3.2639	2.0605	76
9	2.90576	2.59809	64
10	2.58826	3.2764	55
11	2.030378	4.1328	47
12	2.05232	5.20864	41
13	1.8288	6.56984	35
14	1.62814	8.282	32

Load Line Inductance: When using 375XA, voltage drop and voltage generated due to load line inductance and current change must be taken into consideration. Extreme changes in voltage may exceed the minimum or maximum voltage limits, which may damage the 375XA load.

To determine the voltage generated, the following equation can be used.

$$E=L \times (\Delta I / \Delta T)$$

E=voltage generated

L=load line inductance

ΔI =change of current(A)

ΔT =time(us)

Load line inductance (L) can be approximated as 1uH/meter of wire. ($\Delta I / \Delta T$) is the slew rate in A/us

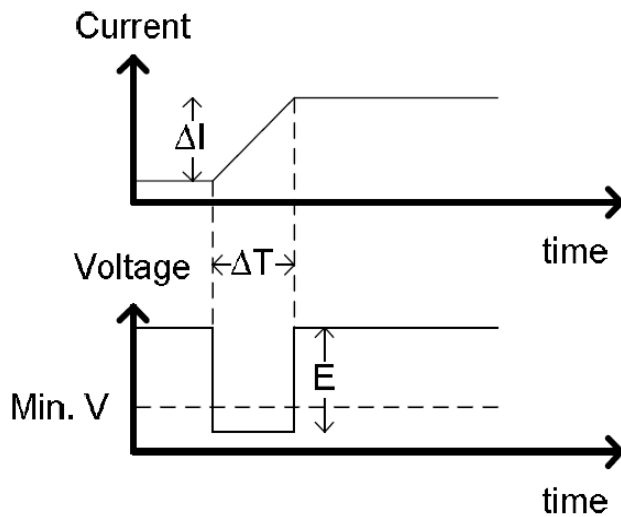

The diagram above shows how changes in current can affect voltage.

Load line inductance can be reduced in two ways:

1. Ensure load wires being as short as possible;
2. Twist the positive and negative load wires together.

Current change can be limited by limiting the slew rate or response speed when switching in CR and CC mode.

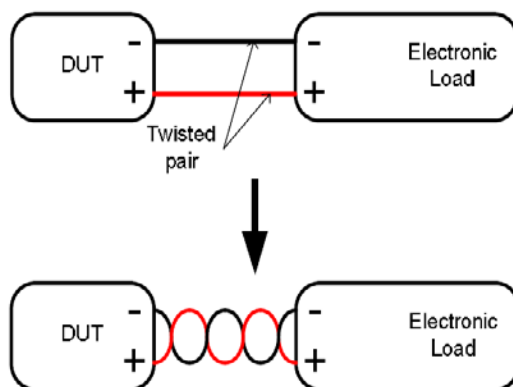

Load Wire Connections

The input terminal of the load is on the rear panel. Strictly follow the procedure below for all the load connections to ensure the safety of the personal and the instrument. Ensure the polarity is correct before proceeding with any connection. Ensure the maximum input voltage is less than 240V.

Using the wrong polarity, when the reverse voltage is greater than $-3V$, the reverse voltage alarm function will be tripped.

Do not touch any of the input terminals when the unit is on.

Connecting the input terminal to the wrong polarity can damage the DUT and load.

Remote Detecting Connection

When the current flows through the load, the voltage between the input terminals is lower than the output voltage due to the resistance of the wire connecting the power supply and the load. The remote voltage detecting terminals can be used to get a more accurate voltage of the power supply. The load will switch to the remote detecting state after the connection. Remote sense can be used to help compensate for long cable length. The longer the cable, the higher the potential resistance and inductance, therefore a short cable is best. For large inductance wire, twist the positive and the negative load wires together can help to reduce the induced inductance, or use V_{sense} terminal to compensate the voltage drop seen across the load leads, especially leads with higher resistance. This is useful in CV, CP and CR mode. The wiring is as shown in Fig. 3-3.



图 3-3

Parallel Load Connections

When a larger power or current is needed, two or more units can be operated in parallel.

Notes: Parallel operation can only be used in CC, CR and CP mode.

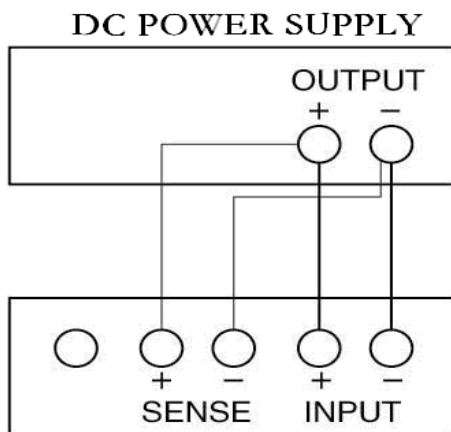
Please refer to Fig. 3-4 for the parallel connection wiring method.



图 3-4

Chapter IV Local Operation

Chapter II Functions & Features briefly introduced the local operation of the load. This chapter will explain the local operation in details with examples.

4.1 Local Control

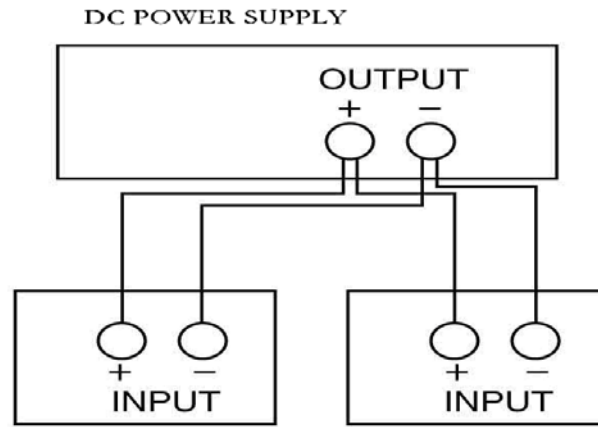
If it is needed to control the load from the front panel, the load must be in local control status. The load enters into local control status when it is powered on. The relevant parameter preset and saved in EEPROM Location 0 will be recalled automatically.

In remote control status, all operations on the front panel and the knob are invalid (except )

When the load receives a remote command: SYSTem:REMote via RS232, USB or GPIB, the remote control goes into effect and the REM annunciator on the right upper corner turns on.

In remote control status, all operations of the load is controlled via the remote control. After receiving the return command: SYSTem:LOCAl, the load will return to local control and the REM annunciator will turns off. Or you can return the load to local control by pressing  key.



4.2 Main Operation of the Front Panel

- **Connecting to the power supply**
- **Turning on/off the input**
- **CC Mode**
- **CV Mode**
- **CR Mode**
- **CP Mode**
- **Continuous Transient Operation**
- **Pulsed Transient Operation**
- **Toggled Transient Operation**
- **List Operation**
- **Saving and Recalling Parameters**
- **Clear Protection Settings**
- **Error Messages**





- **Trigger Operation**
- **Main Menu**

4.3 Connecting to the Power Supply

Connect the positive pole of the power supply to the red terminal “+” of the input (INPUT) on the rear panel, and connect the negative pole of the power supply to the black terminal “-” of the input (INPUT) on the rear panel. If the input is connected reversely, the RV protection status of the load will become effective. In this case, please re-connect the power supply and the electronic load.











After correctly connecting the power supply and the electronic load, press the  key and the  key to clear the RV protection status or restart the load. The details will be described in “Clearing Protection Settings” as below.

4.4 ON/OFF of the Eload Input

The load can be turned on and off by pressing  key. The  key will be green  when the load is ON and then  key will be orange  when the load is OFF.

4.5 Basic Operation

The operation procedures of the basic test is as follows:

1. Press function key , , , or  to enter the mode and parameter setting menu;
2. Select the setting parameter by using  and  keys;
3. Enter the set value via number keypad, or knob with  and  keys;
4. Press  key to confirm;
5. Press  key to open the input of the load.



4.5.1 CC Mode

CC mode has two ranges: the high range (CCH) and the low range (CCL).



Example 1: Take 3751A as an example, in CVL mode, set the load as CCH mode, the current level is 80A. Turn on the load. The procedures are shown as below:

Step 1: Press  key to enter into  mode and parameter setting menu;

Step 2: Press dynamic  key to select  mode;

Step 3: Enter the current level 80.000 by the number keypad, or via knob with , and  keys;

Step 4: Press  key to confirm;



Step 5: Switch to other optional via  and  keys;



Step 6: Press  key to open the load.

The corresponding SCPI commands of the above procedures should be as follows:

MODE	CCH	; Set the mode
CURR	80	; Set the current level
INP	ON	; Turn on the load



Example 2: In CCH mode, set the current level to 16A, the current rising rate to 0.1A/us, the current falling rate to 0.5A/us, the VON voltage to 10V and the current limit level 25A. Turn on the load. The procedures are shown as below:



Step 1: Switch to parameter setting menu via  and  keys;



Step 2: Move the cursor to the ten position via the  key, then enter number 1 via the knob or the number keypad; move the cursor to the digit position via the  key, then enter number 6 via the knob or the number keypad; then press  key to confirm;



Step 3: Switch to Volt Start option via  and  keys;



Step 4: Move the cursor to the ten position via the  key, then enter number 1 via the knob or



the number keypad; move the cursor to the digit position via the  key, then enter number 0 via the knob or the number keypad; then press  key to confirm;



Step 5: Switch to current limit option via  and  keys;

Step 6: Move the cursor to the ten position via the  key, then enter number 2 via the knob or the number keypad; move the cursor to the digit position via the  key, then enter number 5 via the knob or the number keypad; press  key to confirm;

Step 7: Switch to current rising rate option via  and  keys;

Step 8: Move the cursor to the digit position via the  key, then enter number 0 via the knob or the number keypad; move the cursor to the tenth position via the  key, then enter number 1 via the knob or the number keypad; press  key to confirm;

Step 9: Switch to current falling rate option via  and  keys;

Step 10: Move the cursor to the digit position via the  key, then enter number 0 via the knob or the number keypad; move the cursor to the tenth position via the  key, then enter number 5 via the knob or the number keypad; press  key to confirm;

Step 11: Press  key to open the load.

Notes: The knob changes the set value immediately. While using the number keypad, the  key is needed to press to confirm. Otherwise the operation will be invalid. When the load is open, the set value will be valid in the input terminal immediately.

The corresponding SCPI commands of the above procedures should be as follows:

```

MODE      CCH           // Set the mode
CURR      16           // Set the current level
CURR:SLEW:POS 0.1     // Set the current rising rate 0.1A/us
CURR:SLEW:NEG 0.5     // Set the current falling rate 0.5A/us
VOLT:STAR 10          // Set the VON voltage 10V
CURR:LIM  25          // Set the current limit 25A

```

INP ON // Open the load

Notes: In CCH or CCL status, the **CCH** or the **CCL** will be displayed at the lower right corner.

4.5.2 CV Mode

Example 1: Take 3751A as an example, in CCH mode, set the load as CVH mode, the voltage level is 50V. Turn on the load. The procedures are shown as below:

Step 1: Press **CV** key to enter into **CVL** mode and parameter setting menu;

Step 2: Press dynamic **H/L** key to select **CVH** mode;

Step 3: Enter the voltage level 50 by the number keypad, or via knob with **◀**, and **▶** keys;

Step 4: Press **Enter** key to confirm;

Step 5: Press **Input on/off** key to turn on the load.

The corresponding SCPI commands of the above procedures should be as follows:

```
MODE        CVL                            ; Set the mode
CURR        50                            ; Set the voltage level
INP         ON                            ; Turn on the load
```



Example 2: In CVH mode, set the voltage level to 60V, the Volt Start to 20V, the voltage limit to 100V, the voltage rising rate 20V/us and the voltage falling rate 24V/us. Turn on the load. The procedures are shown as below:



Step 1: Switch to parameter setting menu via **▲** and **▼** keys;





Step 2: Move the cursor to the ten position via the **◀** key, then enter number 6 via the knob or the number keypad; move the cursor to the digit position via the **▶** key, then enter number 0 via the knob or the number keypad; then press **Enter** key to confirm;



Step 3: Switch to Volt Start option via **▲** and **▼** keys;



Step 4: Move the cursor to the ten position via the **◀** key, then enter number 2 via the knob or



the number keypad; move the cursor to the digit position via the  key, then enter number 0 via the knob or the number keypad; then press  key to confirm;



Step 5: Switch to voltage limit option via  and  keys;

Step 6: Move the cursor to the hundred position via the  key, then enter number 1 via the knob or the number keypad; Move the cursor to the ten position via the  key, then enter number 0 via the knob or the number keypad; move the cursor to the digit position via the  key, then enter number 0 via the knob or the number keypad; press  key to confirm;

Step 7: Switch to voltage rising rate option via  and  keys;

Step 8: Move the cursor to the ten position via the  key, then enter number 2 via the knob or the number keypad; move the cursor to the digit position via the  key, then enter number 0 via the knob or the number keypad; press  key to confirm;

Step 9: Switch to voltage falling rate option via  and  keys;

Step 10: Move the cursor to the ten position via the  key, then enter number 2 via the knob or the number keypad; move the cursor to the digit position via the  key, then enter number 4 via the knob or the number keypad; press  key to confirm;

Step 11: Press  key to open the load.

Notes: The knob changes the set value immediately. While using the number keypad, the  key is needed to press to confirm. Otherwise the operation will be invalid. When the load is open, the set value will be valid in the input terminal immediately.

The corresponding SCPI commands of the above procedures should be as follows:

MODE	CVH	; Set the mode
VOLT	60	; Set the voltage level
VOLT:SLEW:POS	20	; Set the voltage rising rate 20V/us
VOLT:SLEW:NEG	24	; Set the voltage falling rate 24V/us
VOLT:STAR	20	; Set the VON voltage 20V

VOLT:LIM 100 ; Set the voltage limit level 100V

INP ON ; Open the load

Notes: In CV mode, the green **CVH** will be displayed in the LCD.

Example 3: Take 3751A as an example, in CCH mode, set the load to CVL mode, the voltage level is 50V. Turn on the load. The procedures are shown as below:

Step 1: Press  key to enter into **CVL** mode and parameter setting menu;

Step 2: Enter the voltage 10 by the number keypad, or via knob with , and  keys;

Step 4: Press  key to confirm;

Step 5: Press  key to open the load.

The corresponding SCPI commands of the above procedures should be as follows:

MODE CVL ; Set the mode

VOLT 10 ; Set the voltage level



INP ON ; Open the load

4.5.3 CR Mode

CR mode has two ranges: the high range (CRH) and the low range (CRL).

Example 1: Take 3751A as an example, in CV mode, set the load as CRL mode, the resistance level is 1.5Ω. Turn on the load. The procedures are shown as below:

Step 1: Press  key to enter into **CRL** mode and parameter setting menu;

Step 2: Enter the resistance level 1.5 by the number keypad, or via knob with , and  keys;

Step 3: Press  key to confirm;

Step 4: Press  key to open the load.



The corresponding SCPI commands of the above procedures should be as follows:



MODE CRL ; Set the mode



RES 1.5 ; Set the resistance level



INP ON ; Open the load



Example 2: In CRH mode, set the resistance level to 20K Ω , the Volt Start voltage to 15V, the resistance limit to 80K Ω , the current rising rate 0.5A/us and the current falling rate 0.2A/us. Turn on the load. The procedures are shown as below:



Step 1: Switch to parameter setting menu via  and  keys;



Step 2: Move the cursor to the ten position via the  key, then enter number 2 via the knob or the number keypad; move the cursor to the digit position via the  key, then enter number 0 via the knob or the number keypad; then press  key to confirm;



Step 3: Switch to Volt Start voltage option via  and  keys;

Step 4: Move the cursor to the ten position via the  key, then enter number 2 via the knob or the number keypad; move the cursor to the digit position via the  key, then enter number 0 via the knob or the number keypad; then press  key to confirm;



Step 5: Switch to resistance limit option via  and  keys;

Step 6: Move the cursor to the ten position via the  key, then enter number 8 via the knob or the number keypad; move the cursor to the digit position via the  key, then enter number 0 via the knob or the number keypad; press  key to confirm;

Step 7: Switch to current rising rate option via  and  keys;

Step 8: Move the cursor to the digit position via the  key, then enter number 0 via the knob or the number keypad; move the cursor to the tenth position via the  key, then enter number 5 via the knob or the number keypad; press  key to confirm;

Step 9: Switch to current falling rate option via  and  keys;

Step 10: Move the cursor to the digit position via the  key, then enter number 0 via the knob or the number keypad; move the cursor to the tenth position via the  key, then enter number

2 via the knob or the number keypad; press  key to confirm;

Step 11: Press  key to open the load.

Notes: The knob changes the set value immediately. While using the number keypad, the  key is needed to press to confirm. Otherwise the operation will be invalid. When the load is open, the set value will be valid in the input terminal immediately.

The corresponding SCPI commands of the above procedures should be as follows:



MODE	CRH	; Set the mode
RES	20KR	; Set the resistance level
CURR:SLEW:POS	0.5	; Set current rising rate 0.5A/us
CURR:SLEW:NEG	0.2	; Set current falling rate 0.2A/us
VOLT:STAR	15	; Set VON voltage 15V
RES:LIM	80KR	; Set resistance limit 80KΩ
INP	ON	; Open the load

Notes: In CRH or CRL status, the green **CRH** or the green **CRL** will be displayed at the lower right corner.

4.5.4 CP Mode

Example 1: Take 3751A as an example, in CRL mode, set the load to CP mode, the power level is 1000W. Turn on the load. The procedures are shown as below:

Step 1: Press  key to enter into **CP** mode and parameter setting menu;

Step 2: Enter the power level 1000 by the number keypad, or via knob with  and  keys;

Step 3: Press  key to confirm;

Step 4: Press  key to open the load.

The corresponding SCPI commands of the above procedures should be as follows:



MODE	CPV	; Set the mode
------	-----	----------------



POW 1000 ; Set the power level



INP ON ; Open the load



Example 2: Take 3751A as an example, in CRH mode, set the load to CP mode, the power level to 1000W, the VON voltage to 15V, the power limit to 1200W, the current rising rate 10A/us and the current falling rate 6A/us. Turn on the load. The procedures are shown as below:



Step 1: Press  key to enter into  mode and parameter setting menu;



Step 2: Switch to parameter setting menu via  and  keys;



Step 3: Move the cursor to the thousand position via the  key, then enter number 1 via the knob or the number keypad; move the cursor to other positions via the  key, then enter number 0 via the knob or the number keypad; then press  key to confirm;



Step 4: Switch to VON voltage option via  and  keys;



Step 5: Move the cursor to the ten position via the  key, then enter number 2 via the knob or the number keypad; move the cursor to the digit position via the  key, then enter number 0 via the knob or the number keypad; then press  key to confirm;



Step 6: Switch to current limit option via  and  keys;

Step 7: Move the cursor to the ten position via the  key, then enter number 7 via the knob or the number keypad; move the cursor to the digit position via the  key, then enter number 0 via the knob or the number keypad; press  key to confirm;

Step 8: Switch to current rising rate option via  and  keys;

Step 9: Move the cursor to the ten position via the  key, then enter number 1 via the knob or the number keypad; move the cursor to other positions via the  key, then enter number 0 via the knob or the number keypad; press  key to confirm;

Step 10: Switch to current falling rate option via  and  keys;

Step 11: Move the cursor to the digit position via the  key, then enter number 0 via the knob or the number keypad; move the cursor to the tenth position via the  key, then enter number 2 via the knob or the number keypad; press  key to confirm;

Step 12: Press  key to open the load.

Notes: The knob changes the set value immediately. While using the number keypad, the  key is needed to press to confirm. Otherwise the operation will be invalid. When the load is open, the set value will be valid in the input terminal immediately.

The corresponding SCPI commands of the above procedures should be as follows:



MODE	CP	; Set the mode
POW	1000	; Set the power level
CURR:SLEW:POS	10	; Set current rising rate 10A/us
CURR:SLEW:NEG	6	; Set current falling rate 6A/us
VOLT:STAR	20	; Set VON voltage 20V
POW:LIM	1200	; Set power limit level 1200W
INP	ON	; Open the load



4.6 +CV Mode

4.6.1 CC+CV Mode



Example : Take 3751A as an example, in CCH mode, set the load to CCH mode, the current level to 80A, the voltage limit to 50V. Turn on the load. The procedures are shown as below:



Step 1: Switch to  mode by pressing  and  key simultaneously;

Step 2: Switch to parameter setting menu via  and  keys;

Step 3: Enter the current level 80.00 by the number keypad, or via knob with  and  keys;

Step 4: Press  key to confirm;

Step 5: Switch to voltage limit option via  and  keys;

Step 6: Enter the voltage level 50.000 by the number keypad, or via knob with  and  keys;

Step 7: Press  key to confirm;

Step 8: Press  key to open the load.



The corresponding SCPI commands of the above procedures should be as follows:



MODE	CCH+CV	;	Set the mode
CURR	80	;	Set the current level
VOLT:ADD:LIM	50	;	Set the voltage limit level 50V
INP	ON	;	Open the load

4.6.2 CR+CV Mode



Example 1: Take 3751A as an example, in CRL mode, set the resistance level to 1.5Ω, the voltage limit to 20V. Turn on the load. The procedures are shown as follows:



Step 1: Switch to **CRL+CV** mode by pressing  and  key simultaneously;

Step 2: Switch to parameter setting menu via  and  keys;

Step 3: Enter the resistance level 1.5 by the number keypad, or via knob with  and  keys;

Step 4: Press  key to confirm;

Step 5: Switch to voltage limit option via  and  keys;

Step 6: Enter the voltage level 20.000 by the number keypad, or via knob with  and  keys;

Step 7: Press  key to confirm;

Step 8: Press  key to open the load.

The corresponding SCPI commands of the above procedures should be as follows:

MODE	CRL+CV	;	Set the mode
RES	1.5	;	Set the resistance level
VOLT:ADD:LIM	20	;	Set the voltage limit level
INP	ON	;	Open the load

4.6.3 CP+CV Mode

Example : Take 3751A as an example, in CP mode, set the power to 1000W, the voltage limit to 30V. Turn on the load. The procedures are shown as below:

Step 1: Switch to **CP+CV** mode by pressing **Shift** and **CV** key simultaneously;

Step 2: Switch to parameter setting menu via **▲** and **▼** keys;

Step 3: Enter the current level 1000 by the number keypad, or via knob with **◀** and **▶** keys;

Step 4: Press **Enter** key to confirm;

Step 5: Switch to voltage limit option via **▲** and **▼** keys;

Step 6: Enter the voltage level 30.000 by the number keypad, or via knob with **◀** and **▶** keys;

Step 7: Press **Enter** key to confirm;

Step 8: Press **Input on/off** key to open the load.

The corresponding SCPI commands of the above procedures should be as follows:













MODE	CP+CV	;	Set the mode
POW	1000	;	Set the power level
VOLT:ADD:LIM	30	;	Set the voltage limit level
INP	ON	;	Open the load

4.7 Transient Operation

The operation procedures for transient operation are shown as below:

1. Press dynamic  key to enter into transient mode and the parameter setting menu, as shown in the following diagram:



2. Press function key (, , , ) to select the basic operation mode and press dynamic  key to confirm the high or low of the function.
3. Switch to parameter setting menu via  and  keys;
4. Enter the transient low level, the transient high level, the low level time, the high time, the rising time, the falling time by the number keypad, or via knob with  and  keys;
5. Set the Mode level via knob or dynamic  keys;
6. Press  key to confirm;
7. Press  key to open the load.
8. If it is in pulsed transient operation or the toggled transient operation, one trigger occurs when the signal at the trigger terminal (TRIGIN) is low level.

4.7.1 Continuous Transient Operation

Example : Take 3751A as an example, set the voltage level periodically switch between 10V and 150V, the time for rising edge to 10ms, the high level time to 200ms, the time for falling edge to 20ms and the low level time to 400ms. The load is in continuous transient operation. The

procedures are shown as below:

Step 1: Press dynamic **Tran** key to enter into transient mode and the parameter setting menu;

press **CV** key to enter into **TCVL** mode; then press dynamic **H/L** key to **TCVH** mode; as in the following diagram:



Step 2: Select “L_Level” via **Tab** key or **▲** and **▼** keys; enter the transient low level 10 by the number keypad, or via knob with **◀** and **▶** keys; then press **Enter** key to confirm;







Step 3: Select “H_Level” via **Tab** key or **▲** and **▼** keys; enter the transient high level 150 by the number keypad, or via knob with **◀** and **▶** keys; then press **Enter** key to confirm;





Step 4: Select “LowTime” via **Tab** key or **▲** and **▼** keys; enter the low level time 0.40000 by the number keypad, or via knob with **◀** and **▶** keys; then press **Enter** key to confirm;

Step 5: Select “LowTime” via **Tab** key or **▲** and **▼** keys; enter the low level time 0.40000 by the number keypad, or via knob with **◀** and **▶** keys; then press **Enter** key to confirm;

Step 6: Select “RiseTime” via **Tab** key or **▲** and **▼** keys; enter the time for rising edge 0.01000 by the number keypad, or via knob with **◀** and **▶** keys; then press **Enter**

key to confirm;

Step 7: Select “FallTime” via  key or  and  keys; enter the time for falling edge 0.02000 by the number keypad, or via knob with  and  keys; then press  key to confirm;

Step 8: Select “Mode” via  key or  and  keys; select Cont via knob or dynamic  keys; then press  key to confirm;



Step 9: Press  key to open the load.







The corresponding SCPI commands of the above procedures should be as follows:







MODE	CVH	;	Set the mode
SYST:STAT	TRAN	;	Enter into transient mode
VOLT	10	;	Set the transient low level
VOLT:TLeVel	150	;	Set the transient high level
TRAN:LTIME	400ms	;	Set the low level time
TRAN:HTIME	200ms	;	Set the high level time
TRAN:RTIME	10ms	;	Set the time for rising edge
TRAN:FTIMR	20ms	;	Set the time for falling edge
TRAN:MODE	CONT	;	Select transient operation mode
INP	ON	;	Open the mode







4.7.2 Pulsed Transient Operation







Example : If the load is in external trigger mode, set the voltage level periodically switch between 1A and 5A, the time for rising edge to 10us, the high level time to 1ms, the time for falling edge to 10us and the low level time to 1ms. The load is in pulse transient operation and executes one trigger simultaneously. The procedures are shown as below:







Step 1: Press dynamic  key to enter into transient mode and the parameter setting menu; press  key to enter into  mode;







Step 2: Select “L_Level” via  key or  and  keys; enter the transient low level 1 by the number keypad, or via knob with  and  keys; then press  key to confirm;





Step 3: Select “H_Level” via  key or  and  keys; enter the transient high level 5 by the number keypad, or via knob with  and  keys; then press  key to confirm;

Step 4: Select “LowTime” via  key or  and  keys; enter the low level time 0.00100 by the number keypad, or via knob with  and  keys; then press  key to confirm;

Step 5: Select “HighTime” via  key or  and  keys; enter the high level time 0.00100 by the number keypad, or via knob with  and  keys; then press  key to confirm;

Step 6: Select “RiseTime” via  key or  and  keys; enter the time for rising edge 0.00001 by the number keypad, or via knob with  and  keys; then press  key to confirm;

Step 7: Select “FallTime” via  key or  and  keys; enter the time for falling edge 0.00001 by the number keypad, or via knob with  and  keys; then press  key to confirm;

Step 8: Select “Mode” via  key or  and  keys; select **Pulse** via knob or dynamic  keys; then press  key to confirm;

Step 9: Press  key to open the load;

Step 10: Send the load the trigger initial command: INIT or INIT: CONT;





Step 11: The signal at the trigger terminal (TRIG IN) is low and the load executes one trigger.







The corresponding SCPI commands of the above procedures should be as follows:







MODE	CCL	;	Set the mode
SYST:STAT	TRAN	;	Enter into transient mode
CURR	1	;	Set the transient low level
CURR: TLeVel	5	;	Set the transient high level
TRAN:LTIME	1ms	;	Set the low level time
TRAN:HTIME	1ms	;	Set the high level time
TRAN:RTIME	10us	;	Set the time for rising edge
TRAN:FTIMR	10us	;	Set the time for falling edge
TRAN:MODE	PULS	;	Select transient operation mode
INP	ON	;	Open the load
INIT		;	Trigger initialization
TRIG		;	Execute one pulse operation





4.7.3 Toggle Transient Operation





Example : If the load is in external trigger mode, set the resistance level periodically switch between 200Ω and 500Ω, the time for rising edge to 10ms, the high level time to 200ms, the time for falling edge to 10ms and the low level time to 100ms. The load is in toggle transient operation and executes one trigger simultaneously. The procedures are shown as below:





Step 1: Press dynamic  key to enter into transient mode and the parameter setting menu; press  key to enter into  mode; then press dynamic  key to  mode;





Step 2: Select “L_Level” via  key or  and  keys; enter the transient low level 0.2 by the number keypad, or via knob with  and  keys; then press  key to confirm;



Step 3: Select “H_Level” via  key or  and  keys; enter the transient high level 0.5 by the number keypad, or via knob with  and  keys; then press  key to confirm;

Step 4: Select “LowTime” via **Tab** key or  and  keys; enter the low level time 0.10000 by the number keypad, or via knob with  and  keys; then press **Enter** key to confirm;

Step 5: Select “LowTime” via **Tab** key or  and  keys; enter the low level time 0.10000 by the number keypad, or via knob with  and  keys; then press **Enter** key to confirm;

Step 6: Select “RiseTime” via **Tab** key or  and  keys; enter the time for rising edge 0.01000 by the number keypad, or via knob with  and  keys; then press **Enter** key to confirm;

Step 7: Select “FallTime” via **Tab** key or  and  keys; enter the time for falling edge 0.01000 by the number keypad, or via knob with  and  keys; then press **Enter** key to confirm;

Step 8: Select “Mode” via **Tab** key or  and  keys; select **Togg** via knob or dynamic **Mode** keys; then press **Enter** key to confirm;

Step 9: Press **Input on/off** key to open the load;

Step 10: Send the load the trigger initial command: INIT or INIT: CONT;

Step 11: The signal at the trigger terminal (TRIG IN) is low and the load executes one trigger.

The corresponding SCPI commands of the above procedures should be as follows:

MODE	CRL	; Set the mode
SYST:STAT	TRAN	; Enter the transient operation
RES	200	; Set the transient low level
RES: TLEV	500	; Set the transient high level
TRAN:LTIME	200ms	; Set the low level time
TRAN:HTIME	200ms	; Set the high level time
TRAN:RTIME	1ms	; Set the time for rising edge

TRAN:FTIMR	1ms	; Set the time for falling edge
TRAN:MODE	TOGG	; Select the transient operation mode
INP	ON	; Open the load
INIT		; Trigger initialization
TRIG		; Execute one toggle operation

4.8 List Operation

The operation procedures for list operation are shown as below:

1. Press dynamic **List** key to enter into list operation mode and the parameter setting menu, as shown in the following diagram:



2. Select the “Number” via the number keypad or via the knob and then press **Enter** key to confirm;
3. Select **Name** via **▼** key and set the name ((5 characters) via the knob or the **◀** and **▶** keys; then press **Enter** key to confirm;
4. Select **Chain** via **▼** key and select the sequence number or whether or not link (ON means chained, OFF means non-chained.) via the knob or the **◀** and **▶** keys; then press **Enter** key to confirm;
5. Select **Steps** via **▼** key and select the sequence number or whether or not link (ON means

linking, OFF means non-linking.) via the knob or the ◀ and ▶ keys; then press **Enter** key to confirm; Select the chained sequence number or whether or not chained

6. Select **Step QTY** function via ▼ key and enter the set step number via the knob or the ◀ and ▶ keys; then press **Enter** key to confirm;
7. Press dynamic **Edit** key to enter into function edition menu, as shown in the following diagram:

The screenshot shows a menu titled 'List:00' with a timestamp '2016/08/08 10:23'. It contains a table with the following data:

Step	Mode	Value	A	Time
001	CCL	5.0000	A	5.0000 s
002	CCL	0.0000	A	0.0000 s
003	CCL	0.0000	A	0.0000 s
004	CCL	0.0000	A	0.0000 s
005	CCL	0.0000	A	0.0000 s

At the bottom of the screen, there are four dynamic keys: **Esc**, **H/L**, **Prev**, and **Next**.

8. Select the **step number** via ▲ and ▼ keys; then select the editing parameter via TAB key; then make the selection via the ◀ and ▶ key or the knob and enter the value via the keypad; then press **Enter** key to confirm and save the data into the designed EEPROM;
9. Press dynamic **ESC** key to return to the list operation menu;
10. Press dynamic **Start** key to start the list operation program;
11. At starting status, press dynamic **Stop** key to stop the list operation program;
12. In the list operation menu, press dynamic **Clear** key, system will eliminate the program at current number

4.8.1 List Editing

Example : Edit a new sequence. The sequence number is 0; the sequence name is Test0. The sequence steps: Step 1: CCL, 1A, 1S; Step 2: CCH, 10V, 1S; Step 3: CVH, 10V, 1S; Step 4: CRL,

1Ω, 1S; Step 5: CP, 200W, 1S. The cycle times is 10; disable the sequence chain; start the sequence operation; stop the sequence operation. The operation procedures are as below:

Step 1: Press dynamic **List** key to enter into list operation mode and the parameter setting menu at initial interface, as shown in the following diagram:



Step 2: Set the sequence **Number** to 0 via the keypad or via the knob and then press **Enter** key to confirm;

Step 3: Select **Name** via **▼** key and set the name to Test0 via **◀** and **▶** keys and the knob;

Step 4: Select **Chain** via **▼** key and edit the chain option to OFF via **◀** and **▶** keys or the knob;

Step 5: Select **Steps** via **▼** key and edit the step quantity number to 5 via **◀** and **▶** keys or the knob;







Step 6: Select **Loops** via **▼** key and edit the value to 10 via **◀** and **▶** keys or the knob;







Step 7: Press dynamic **Edit** key to enter into function edition menu, as shown in the following diagram:







2016/08/08 10:36







Step	Mode	Value		Time	
001	CCL	5.0000	A	5.0000	s
002	CCL	0.0000	A	0.0000	s
003	CCL	0.0000	A	0.0000	s
004	CCL	0.0000	A	0.0000	s
005	CCL	0.0000	A	0.0000	s

Esc H/L Prev Next

Step 8: Select Step 001 via  and  keys; select **Mode** and set mode to CCL via the knob; then select **Value** option via TAB key; set the value to 1.0000 via  and  keys or via the knob; then select **Time** option via TAB key; set the value to 1.000 via  and  keys or via the knob;

Step 9: Select Step 002 via  and  keys; select **Mode** and set mode to CCH via the knob; then select **Value** option via TAB key; set the value to 20.000 via  and  keys or via the knob; then select **Time** option via TAB key; set the value to 1.0000 via  and  keys or via the knob;

Step 10: Select Step 003 via  and  keys; select **Mode** and set mode to CVH via the knob; then select **Value** option via TAB key; set the value to 10.000 via  and  keys or via the knob; then select **Time** option via TAB key; set the value to 1.0000 via  and  keys or via the knob;

Step 11: Select Step 004 via  and  keys; select **Mode** and set mode to CRL via the knob; then select **Value** option via TAB key; set the value to 1.0000 via  and  keys or via the knob; then select **Time** option via TAB key; set the value to 1.0000 via  and  keys or via the knob;

Step 12: Select Step 005 via  and  keys; select **Mode** and set mode to CP via the knob;

then select **Value** option via TAB key; set the value to 200.00 via ◀ and ▶ keys or via the knob; then select **Time** option via TAB key; set the value to 1.0000 via ◀ and ▶ keys or via the knob;

Step 13: Press dynamic **ESC** key to return to the list operation menu;

Step 14: Press dynamic **Start** key to start the current list operation program and it will stop automatically when the operation is finished;

Step 15: During the list operation, press dynamic **Stop** key to stop the running list operation.

The corresponding SCPI commands of the above procedures should be as follows:

LIST: NUMB 0 ; Call the sequence numbered 0
 LIST: MEMO "Test0" ; Name the sequence Test.
 LIST: EDIT 0, CCL,1A,1S
 LIST: EDIT 1, CCH,20A,1S
 LIST: EDIT 2, CVH,10V,1S
 LIST: EDIT 3, CRL,1R,1S
 LIST: EDIT 4, CP,200W,1S ; The above five commands are the sequence steps
 LIST: COUN 10 ; Cyclic time
 LIST: CHA OFF ; Close the chained sequence of the list
 LIST ON ; Start the list operation
 LIST OFF ; Stop the list operation

4.8.2 Starting/Stopping the List

Example: Start the No. 0 sequence and stop the active list operation.

Step 1: Press dynamic **List** key to enter into list operation mode at initial interface;

Step 2: Set the NO to 0 via the keypad or via the knob and press **Enter** key to confirm (The recall number should be the sequence number in EEPROM.);

Step 3: Press dynamic **Start** key to start the current list operation

Step 4: Press dynamic **Stop** key to stop the list operation;

Step 5: Press dynamic  key to return to the initial operation menu.

The corresponding SCPI commands of the above procedures should be as follows:

```
LIST: NUMB 0 ; Call the sequence numbered 0
LIST ON ; Start the list operation
LIST OFF ; Stop the list operation
```

4.9 Saving and Recalling





The operation procedures for transient operation are shown as below:

Press dynamic  key to enter into transient mode and the parameter setting menu, as shown in the following diagram:

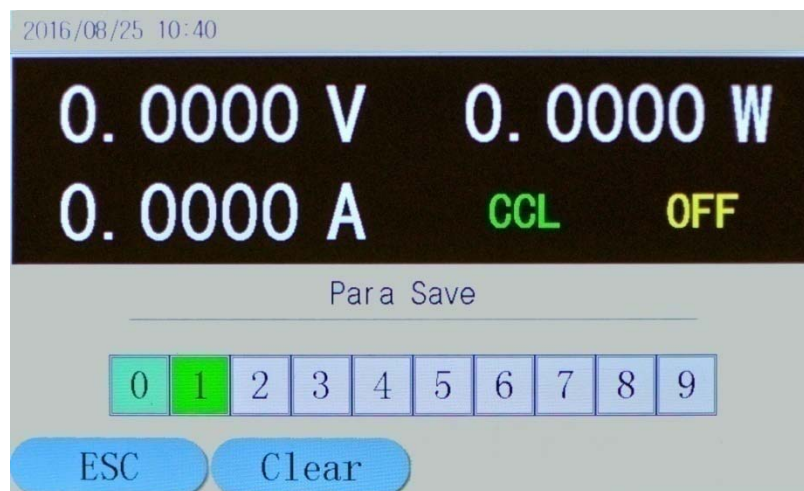
The saving and recalling operation procedures are as followings:

1. Press **SAVE** key to enter into the saving menu as in the following diagram; or press **CALL** key to enter into the recalling menu of the load:







2. Press  and  keys or the knob to select the saving or recalling location;
3. Press  key to confirm. The parameters will be saved into the EEPROM. If the pointed location has saved value in the EEPROM, the location will be green as in the above diagram;
4. Select the saved location via  and  keys or via the knob and press dynamic **Clear** key to eliminate the value of the location, then the location will not be green any more.

Example 1: Set the load to CCL mode; set the current be 2A. Open the load; save the parameters of the status to location 0 in the EEPROM; open the load and upload automatically:

Step 1: Set the load CCL mode and the current 2A, then open the load (For details, please refer to 4.5.1.);

Step 2: Press **SAVE** key to enter into the saving interface of the load;

Step 3: Select the saved Location 0 via  and  keys or the knob;

Step 4: Press  key to confirm the saving, and then press dynamic  key to exit the saving menu of the load.



The corresponding SCPI commands of the above procedures should be as follows:



MODE	CCH	; Set the load CCH mode
CURR	2	; Set the current level 2A
INP	ON	; Open the load
*SAV	0	; Save the parameters to Location 0 in the EEPROM

Example 2: Based on the above example, set the load CV mode; set the voltage be 40V. Turn off the load. Recall the values saved in Location 0 in EEPROM. And the detailed operation procedures are as below:

Step 1: Set the load CV mode and the voltage 40V, then turn off the load (For details, please refer to 4.5.2.);

Step 2: Press **CALL** key to enter into the recalling interface of the load;

Step 3: Select the recalling location: Location 0 via  and  keys or the knob;

Step 4: Press  key to confirm the saving, and then press dynamic  key to exit the recalling menu of the load.

The corresponding SCPI commands of the above procedures should be as follows:

MODE	CV	; Set the load CV mode
VOLT	40	; Set the voltage level 40V

- INP OFF ; Turn off the load
- *RCL 0 ; Recall the values in Location 0 in EEPROM

4.10 Checking and Clearing Protection Setting

The operation procedures for checking and clearing protection setting are shown as below:

1. Eliminate the reasons for the protection of electronic load first;
2. Press Error key to enter into error message displaying interface, as shown in the following diagram:



3. The error message displaying interface will display the error that occurred after the last time the system had introduced.
4. Press dynamic  key to return to the system initial interface;
5. If the errors have been ruled out, the system will no longer display the next time you enter the error interface.

Example : Clear RV protection of the load. The detailed procedures are as below:

Step 1: Correctly re-connect the power supply and the electronic load;

Step 2: Press ERROR key to enter the error messages interface and check the occurred error;

Step 3: Press dynamic EXIT key to exit the error messages interface.

The corresponding SCPI commands of the above procedures should be as follows:

- SYST:ERR? ; Check the error code and information

INP:PROT:CLE ; Clear the protection status

4.11 Trigger Operation

When the trigger mode is external mode (EXternal), the operation procedures for trigger operation are shown as below:

1. Set the trigger function (Refer to 2.8 for details.);
2. The trigger terminal (TRIGIN) receives a TTL falling edge signal, and a trigger occurs.

Example 1: Select “List” for the trigger function to trigger a sequence operation. The sequence is the one mentioned in Example 1 in 4.8.1. The detailed procedures are as below:

Procedures	Detailed Operation
Step 1	Select “List” in main menu for the trigger function (Please refer to 4.14.6 for details.) ;
Step 2	Send initial command INT or INIT:CONT;
Step 3	Trigger terminal (TRIG IN) receives the TTL falling edge. The load’s input will change according to the sequence parameters.

The corresponding SCPI commands of the above procedures should be as follows:

TRIG:FUNC LIST ; Select LIST for the trigger function

INIT ; Trigger initialization







TRIG ; A trigger occurs

4.12 Main Menu of the Eload

The operation procedures for the main menu are shown as below:

1. Press dynamic  key to enter the main menu as the following diagram:











2. Press , ,  and  keys to select the menu item;
3. Press  key to confirm;
4. Press dynamic  key to exit the main menu.

4.12.1 Buzzer

Example: Buzzer disabled. The detailed procedures are as below:

Step 1: Press dynamic  key to enter into the main menu;

Step 2: Select **Buzzer** via ,  keys or ,  keys and press  key to confirm;





Step 3: The following diagram will be displayed. Select **Disabled** via ,  keys and then press  key to confirm;



Step 4: Press dynamic  key to exit the main menu.

4.12.2 Encoder

Example: Encoder disabled. The detailed procedures are as below:

Step 1: Press dynamic  key to enter into the main menu;

Step 2: Select **Encoder** via ,  keys or ,  keys and press  key to confirm;

Step 3: The following diagram will be displayed. Select **Disabled** via ,  keys and then

press  key to confirm;



Step 4: Press dynamic  key to exit the main menu.

4.12.3 Trigger

Example: Encoder disabled. The detailed procedures are as below:

Step 1: Press dynamic  key to enter into the main menu;

Step 2: Select **Trigger** via ,  keys or ,  keys and press  key to confirm;

Step 3: The following diagram will be displayed. Select **Disabled** via ,  keys and then press  key to confirm;

Step 4: Press dynamic  key to exit the main menu.





4.14.6 Calibration

Refer to <<375XA Calibration Manual>> for details.

4.12.5 Information

Example: Check device information. The detailed procedures are as below:

Step 1: Press dynamic  key to enter into the main menu;

Step 2: Select **Device** via ,  keys or ,  keys and press  key to confirm;

Step 3: The following diagram will be displayed;

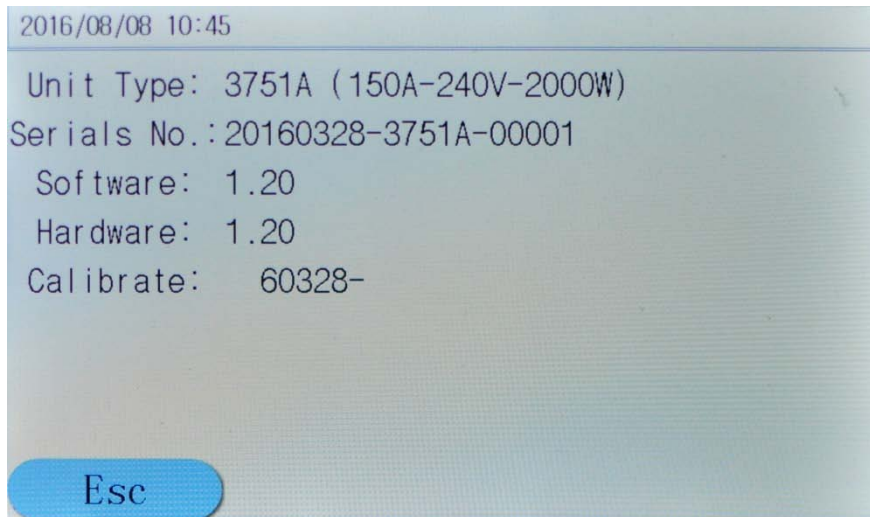

Step 4: Press dynamic  key to exit the main menu.

4.12.6 Safety Code

Change the safety code. The detailed procedures are as below:

Step 1: Press dynamic  key to enter into the main menu;

Step 2: Select **Secure** via ,  keys or ,  keys and press  key to confirm;

Step 3: The following diagram will be displayed;





Step 4: Press dynamic  key to exit the main menu.

Example 1: Change the safety code to 123456. The detailed procedures are as below:

Step 1: Press dynamic  key to enter into the main menu;

Step 2: Select **Secure** via ,  keys or ,  keys and press  key to confirm;

Step 3: The above diagram will be displayed;

Step 4: Enter the system safety code: 003751 (the factory default safety code) via the number keypad, then press  key to confirm. Step 5: Enter 123456 via the number keypad and press  key to confirm. Press dynamic  key to exit the main menu.



Example 2: Cancel the safety code. The detailed procedures are as below:

Step 1: Press dynamic  key to enter into the main menu;

Step 2: Select **Secure** via ,  keys or ,  keys and press  key to confirm;

Step 3: The above diagram will be displayed.

Step 4: Enter the system safety code: 003751 (the factory default safety code) via the number keypad, then press  key to confirm.

Step 5: Press  key to confirm directly without entering any character. Then press dynamic  key to exit the main menu.

4.12.7 Date

Example: Check date information. The detailed procedures are as below:

Step 1: Press dynamic  key to enter into the main menu;

Step 2: Select **Date** via ,  keys or ,  keys and press  key to confirm;

Step 3: The following diagram will be displayed;

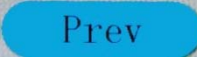
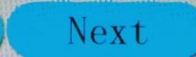
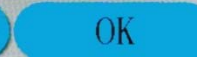
2016 - 8 - 25						
Sun	Mon	Tus	Wen	Tur	Fr i	Sat
	1	2	3	4	5	6
7	8	9	10	11	12	13
14	15	16	17	18	19	20
21	22	23	24	25	26	27
28	29	30	31			
   						

Step 4: Select the set date via ▲, ▼ keys or ◀, ▶ keys. After pressing Enter key, the initial interface will display the set date;

Step 5: Press dynamic ESC key to exit the main menu.

4.12.8 Time

Example: Check time information. The detailed procedures are as below:

Step 1: Press dynamic Menu key to enter into the main menu;

Step 2: Select Time via ▲, ▼ keys or ◀, ▶ keys and press Enter key to confirm;

Step 3: The following diagram will be displayed;

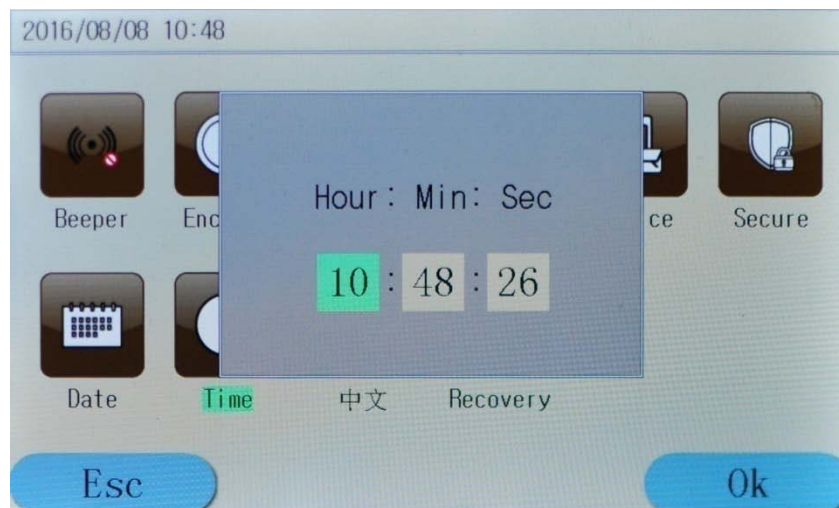

Step 4: Select Hour, Min and Sec via ◀, ▶ keys and regulate the level via the number keypad or the knob. After pressing Enter key, the initial interface will display the set time;

Step 5: Press dynamic ESC key to exit the main menu.

4.12.9 Language

The language of the system can be switched between English and Chinese. The detailed procedures are as below:

Step 1: Press dynamic Menu key to enter into the main menu;

Step 2: Select 中文 via ▲, ▼ keys or ◀, ▶ keys and press Enter key to confirm;

Step 3: The following diagram will be displayed;

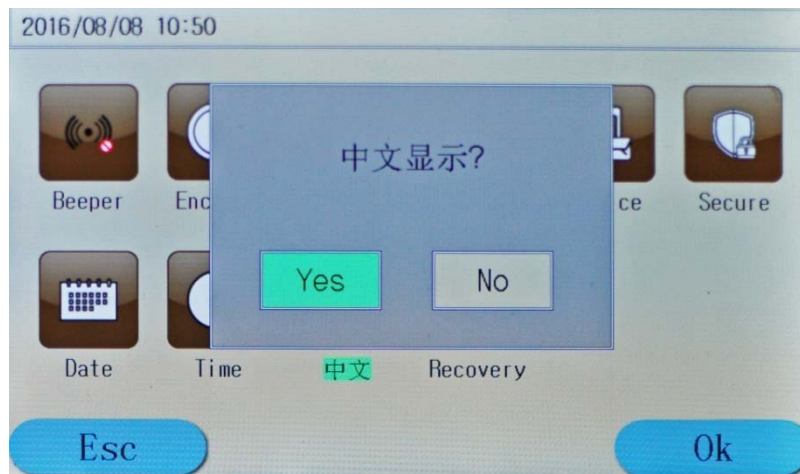

Step 4: If **Yes** is chosen, the language will be switched; if **No** is not chosen, the language will not be switched;

Step 5: Press dynamic **ESC** key to exit the main menu.

4.12.10 System Default

This menu will help to restore the factory default settings. The detailed procedures are as below:

Step 1: Press dynamic **Menu** key to enter into the main menu;

Step 2: Select **Recovery** via **▲**, **▼** keys or **◀**, **▶** keys and press **Enter** key to confirm;

Step 3: In the pop-up dialog, If **Yes** is chosen, it will restore the factory default settings; if **No** is not chosen, it will not restore the factory default settings;

Step 4: Press dynamic **ESC** key to exit the main menu.

Chapter V Remote Programming Operation

The load supports both local operation and remote control. Previous chapters have introduced in details how to operate the load via the front panel keys and the knob. This chapter will introduce how to remote program the load via the remote interfaces. The similarities between the local operation and the remote programming will become apparent as your reading this chapter.

First of all this chapter will help you quickly be familiar with the remote programming. The examples are the simplest SCPI commands. For more detailed explanations, please refer to 《ARRAY 375XA Electronic Load SCPI Programming Guide》.

5.1 Communication Interface

5.1.1 RS232

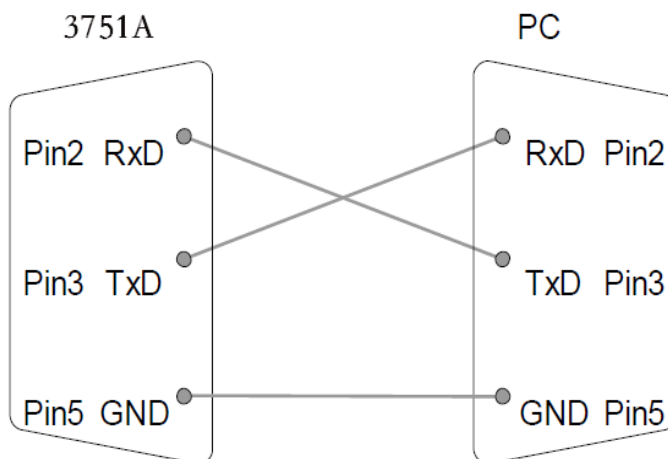

RS232 interface is the standard configuration of the load. Correctly connect the load and the PC via the RS232 interface shipped with the load. Select RS232 interface in the MENU, and set the Baud rate, parity, data bit, stop bit and so on corresponding parameters. Set the same parameters in the PC software. Then input the SCPI commands in the PC software interface to operate the load.

5.1.2 USB

6. **USB interface** is the standard configuration of the load. Correctly connect the load and the PC via the USB interface. Select USB interface in “I/Oconfig” menu. Input the SCPI commands in the PC software interface to operate the load.

5.1.3 GPIB

GPIB interface is the optional configuration of the load. Only installing the GPIB communication module in the load and installing the corresponding GPIB communication module driver in the PC, the function can be used. Correctly connect the load and the PC via the GPIB interface, select GPIB interface in “I/Oconfig” menu, and set the GPIB address. Select different GPIB address in PC software. Input the legal SCPI commands in the PC software interface to operate the load.

Notes:

GPIB address 0~30;

Maximum 15 devices altogether, 20m cable length, 2m between each device;

Unique address assigned to each device.

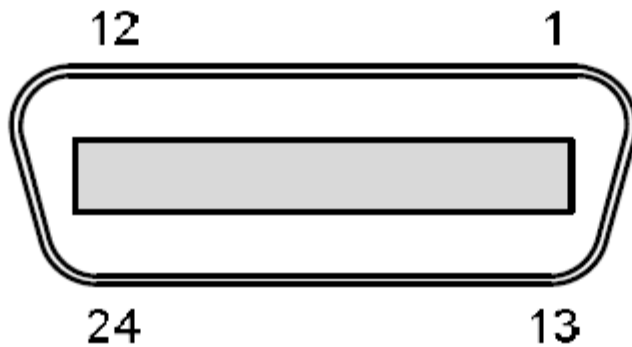

Pin Assignment:

Pin	Signal	Pin	Signal
1~4	Data I/O 1~4	13~16	Data I/O 5~8
5	EOI	17	REN
6	DAV	18	Ground (DAV)
7	NRFD	19	Ground (NRFD)
8	NDAC	20	Ground (NDAC)
9	IFC	21	Ground (IFC)
10	SRQ	22	Ground (SRQ)
11	ATN	23	Ground (ATN)
12	SHIELD Ground	24	Single GND



Example 1: Select RS232 interface, set the Baud rate to 9600, parity to None, data bit to 8, stop bit to 2 and the flow control to ON.



Step 1: Press  key to enter into the I/O configuration set menu as in the following diagram:





Step 2: Select the **COM** menu item via  and  keys, then press  key to enter;



Step 3: Select the **Baud Rate** menu item via  and  keys, set the parameter to 9600 via the knob and then press  key to enter;

Step 4: Select the **Data Bit** menu item via  and  keys, set the parameter to 8 via the knob and then press  key to enter;

Step 5: Select the **Polarity** menu item via  and  keys, set the parameter to None via the knob and then press  key to enter;

Step 6: Select the **Stop Bit** menu item via  and  keys, set the parameter to 2 via the

knob and then press **Enter** key to enter;

Step 7: Press dynamic **ESC** key to exit the **COM** menu;

Step 8: Press dynamic **ESC** key to exit the “**I/OConfig**” menu.

Example 2: Select GPIB communication port and set the address to 4.

Step 1: Press **I/O Config** key to enter into the I/O configuration set menu as in the following diagram:



Step 2: Select the **GPIB** menu item via **◀** and **▶** keys, then press **Enter** key to enter;



Step 3: Set the parameter to 4 via the knob and then press **Enter** key to enter;

Step 4: Press dynamic **ESC** key to exit the **GPIB** menu;

Step 5: Press dynamic **ESC** key to exit the **I/OConfig** menu.

5.2 Remote Programming Display

When the load receives the remote command: SYSTem: REMote via RS232, USB or GPIB, the remote status **Remote** at the upper right corner will be displayed and the load will be in remote control status. In remote control status, all the operations of the keys on the front keypad and the knob (except **Local** key) are invalid. All the operation of the load is controlled by the remote controller. When the load receives the local control command: SYSTem: LOCAl, the remote status **Remote** at the upper right corner will not be displayed and the load will return to local control status. In remote control status, the load will return to local control status when being pressed **Local** key.

5.3 Sending Remote Setting Commands

As local operation on the device, users can remotely set the operation mode and operation parameters of the device for the load from the computer.

5.4 Returning Data

The load can return not only the parameters such as parameter setting level, input voltage level, input current level, input power level and so on but also the internal information and the device identification to the computer. For example, the query command “MEASure: CURRent?” is to ask the load to return the actual current at the input terminal. Please refer to 《Array 375XA Electronic Load SCPI Programming Guide》 for detailed information on the query commands. The load stores and holds the response information to the query command in the output buffer until it is read by the computer or replaced by new information.

5.5 Remote Programming Commands

The SCPI commands have many optional key words for the programmer. Being familiar with those key words will help to know the programming better. Most of the commands have a query syntax which will return the present parameter setting value to the controller. Please refer to

《Array 375XA Electronic Load SCPI Programming Guide》 for detailed information. The main functions of the load can be remotely programmed by some relative commands. Then following points are important when remotely programming the current level, the resistance level, the voltage level and the power level.

5.5.1 Basic Test Mode

No matter the associated basic mode is active or not, the current level, the resistance level, the voltage level and the power level can be remotely programmed. If the input is turned on and the associated mode is selected, the corresponding programmed value will take effect at the input terminal.

5.5.2 Transient Level

The transient high level of CC, CV or CR mode must higher than the respective low level, or the transient operation will be disabled.

5.5.3 Programmable Current Protection

When the programmable current protection is enable, and the programmed current limit and time delay are exceeded, the load's input will be turned off automatically.

5.6 CC Mode Example

Example: Set the current level to 0.5A, and then read back the actual current level.

- 1 "INP OFF" ; Turn off the load's input
- 2 "MODE CCL" ; Select the CCL Mode
- 3 "CURR 0.5" ; Set the current level to 0.5A
- 4 "INP ON" ; Turn on the load's input
- 5 "MEAS:CURR?" ; Measure the actual input current

5.7 CV Mode Example

Example: Preset the trigger voltage to 5V, and then select the external trigger source.

- 1 "INP OFF" ; Turn off the load's input
- 2 "MODE CV" ; Select the CV Mode
- 3 "VOLT:TRIG 5" ; Preset the trigger voltage to 5V
- 4 "TRIG:SOUR EXT" ; Select the external input as the trigger source
- 5 "INP ON" ; Turn on the load's input

In this example, when the external trigger signal is received, the input voltage will be set to 5V.

5.8 CR Mode Example

Example: Set the current protection limit to 10A, the time delay to 10s, the resistance level to 10 Ω and return back the computed power level.

1. "INP OFF" ; Turn off the load's input
2. "MODE CRL" ; Select the CRL Mode
3. "CURR:PROT 10" ; Set the current protection level to 10A
4. "CURR:PROT:DEL 10" ; Set the current protection delay time to 10s
5. "CURR:PROT:STAT ON" ; Active the current protection
6. "RES 10" ; Set the resistance level to 10 Ω
7. "INP ON" ; Turn on the load's input
8. "MEAS:POW?" ; Measure the input power level

5.9 Continuous Transient Operation Example

Example: Set the voltage transient high level, voltage transient low level, time for transient rising edge, time for transient falling edge, high level time, low level time and parameters for transient operations.

- 1 "INP OFF" ; Turn off the load's input
- 2 "MODE CVL" ; Select the CVL Mode
- 3 "SYST:STAT TRAN" ; Open the transient

4 " VOLT 0.5"	; Set the voltage transient low level to 0.5V
5 " VOLT: TLEV 1"	; Set the voltage transient high level to 1V
6 "TRAN:LTIM 200us"	; Set transient low level time to 200us
7 "TRAN:HTIM 300us"	; Set transient high level time to 300us
8 "TRAN:RTIM 10us"	; Set the time for transient rising edge to 10us
9 "TRAN:FTIM 20us"	; Set the time for transient falling edge to 20us
10 "TRAN:MODE CONT "	; Select the continuous transient operation
11 "INP ON"	; Turn on the load's input

5.10 Pulsed Transient Operation Example

Example: Set the CV pulsed transient operation mode, select the BUS as the trigger source, and set a high-level pulse with 1ms width.

1 "INP OFF"	; Turn off the load's input
2 "MODE CVL"	; Select the CVL Mode
3 "SYST:STAT TRAN"	; Open the transient operation function
4 "TRIG:SOUR BUS"	; Select BUS as the trigger source
5 " VOLT 0.5"	; Set the transient low level to 0.5V
6 " VOLT: TLEV 1"	; Set the transient high level to 1V
7 "TRAN:HTIM 1ms"	; Set the transient high level time to 1ms
8 "TRAN:RTIM 10us"	; Set the time for rising edge to 10us
9 "TRAN:FTIM 10us"	; Set the time for falling edge to 10us
10 "TRAN:MODE PULSE "	; Select PULSE as the transient operation mode
11 "INP ON"	; Turn on the load's input
12 "INIT"	; Initialize, waiting for the pulse
13 "*TRG"	; *TRG command generates a 1ms-width high-level pulse at the load's input

Specifications

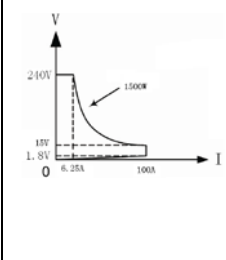
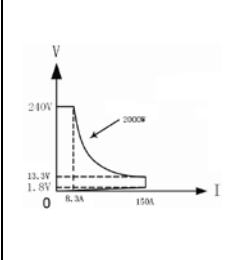
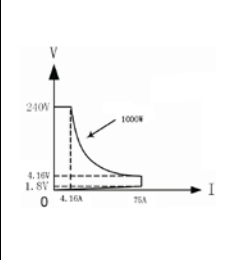
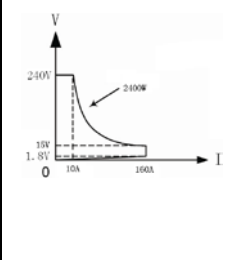
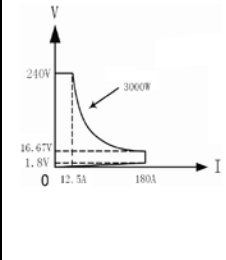
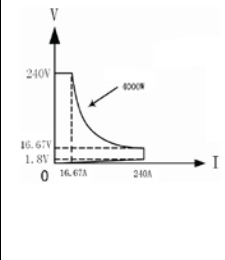
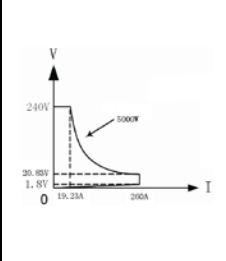
Model	3750A	3751A	3752A	3753A	3754A	3755A	3756A
Current	0~100A	0~150A	0~75A	0~160A	0~180A	0~240A	0~260A
Voltage	0~240V	0~240V	0~240V	0~240V	0~240V	0~240V	0~240V
Power ^{*1}	1500W at 40°C	2000W at 40°C	1000W at 40°C	2400W at 40°C	3000W at 40°C	4000W at 40°C	5000W at 40°C
Input Characteristics							
Constant Current Mode							
Low Range	0~6A	0~6A	0~6A	0~6A	0~8A	0~8A	0~8A
Resolution	0.1mA	0.1mA	0.1mA	0.1mA	0.1mA	0.1mA	0.1mA
Accuracy	0.2%+5mA	0.2%+5mA	0.2%+5mA	0.2%+5mA	0.2%+5mA	0.2%+5mA	0.2%+5mA
High Range	0~100A	0~150A	0~75A	0~160A	0~180A	0~240A	0~260A
Resolution	1mA (0~100A)	1mA (0~100A)	1mA (0~75A)	1mA (0~100A)	1mA (0~100A)	1mA (0~100A)	1mA (0~100A)

Accuracy	0.2%+10mA	10mA (100~150A) 0.2%+10mA	0.2%+10mA	10mA (100~160A) 0.2%+10mA	10mA (100~180A) 0.2%+10mA	10mA (100~240A) 0.2%+10mA	10mA (100~260A) 0.2%+10mA
Constant Voltage Mode							
Range	0~240V	0~240V	0~240V	0~240V	0~240V	0~240V	0~240V
Resolution	1mV (0~100V) 10mV (100~240V)	1mV (0~100V) 10mV (100~240V)	1mV (0~100V) 10mV (100~240V)	1mV (0~100V) 10mV (100~240V)	1mV (0~100V) 10mV (100~240V)	1mV (0~100V) 10mV (100~240V)	1mV (0~100V) 10mV (100~240V)
Accuracy	0.2%+10mV	0.2%+10mV	0.2%+10mV	0.2%+10mV	0.2%+10mV	0.2%+10mV	0.2%+10mV
Constant Resistance Mode							
Low Range	0.2Ω ~240K	0.2Ω ~240K	0.2Ω ~240K	0.2Ω ~240K	0.2Ω ~240K	0.2Ω ~240K	0.2Ω ~240K
Resolution	0.1mΩ	0.1mΩ	0.1mΩ	0.1mΩ	0.1mΩ	0.1mΩ	0.1mΩ
Accuracy @I>6A	0.5%+12mΩ	0.5%+12mΩ	0.5%+12mΩ	0.5%+12mΩ	0.5%+12mΩ	0.5%+12mΩ	0.5%+12mΩ
High Range	0.2KΩ ~2.4MΩ	0.2KΩ ~2.4MΩ	0.2KΩ ~2.4MΩ	0.2KΩ ~2.4MΩ	0.2KΩ ~2.4MΩ	0.2KΩ ~2.4MΩ	0.2KΩ ~2.4MΩ
Resolution	0.001KΩ	0.001KΩ	0.001KΩ	0.001KΩ	0.001KΩ	0.001KΩ	0.001KΩ
Accuracy @I<6A	0.5%+0.12KΩ	0.5%+0.12KΩ	0.5%+0.12KΩ	0.5%+0.12KΩ	0.5%+0.12KΩ	0.5%+0.12KΩ	0.5%+0.12KΩ

Constant Power Mode							
Range	0~1500W	0~2000W	0~1000W	0~2400W	0~3000W	0~4000W	0~5000W
Resolution @P < 100W	1mW	1mW	1mW	1mW	1mW	1mW	1mW
@P≥100W	10mW	10mW	10mW	10mW	10mW	10mW	10mW
@P≥1000W	100mW	100mW	100mW	100mW	100mW	100mW	100mW
Accuracy	0.2%+600mW	0.2%+600mW	0.2%+600mW	0.2%+600mW	0.2%+600mW	0.2%+600mW	0.2%+600mW
Current Measurement							
Low Range	0~6A	0~6A	0~6A	0~6A	0~8A	0~8A	0~8A
Resolution	0.1mA	0.1mA	0.1mA	0.1mA	0.1mA	0.1mA	0.1mA
Accuracy	0.1%+6mA+Vin/50KΩ	0.1%+6mA+Vin/50KΩ	0.1%+6mA+Vin/50KΩ	0.1%+6mA+Vin/50KΩ	0.1%+6mA+Vin/50KΩ	0.1%+6mA+Vin/50KΩ	0.1%+6mA+Vin/50KΩ
High Range	0~100A	0~150A	0~75A	0~160A	0~180A	0~240A	0~260A
Resolution	1mA (0~100A)	1mA (0~100A)	1mA (0~75A)	1mA (0~100A)	1mA (0~100A)	1mA (0~100A)	1mA (0~100A)
Accuracy	± (0.2%+8mA) +Vin/50KΩ	± (0.2%+8mA) +Vin/50KΩ	± (0.2%+8mA) +Vin/50KΩ	± (0.2%+8mA) +Vin/50KΩ	± (0.2%+8mA) +Vin/50KΩ	± (0.2%+8mA) +Vin/50KΩ	± (0.2%+8mA) +Vin/50KΩ
	10mA (100~150A)	10mA (100~150A)		10mA (100~160A)	10mA (100~180A)	10mA (100~240A)	10mA (100~260A)
Voltage Measurement							

Range	0~240V	0~240V	0~240V	0~240V	0~240V	0~240V	0~240V
Resolution	1mV (0~100V) 10mV (100~240V)	1mV (0~100V) 10mV (100~240V)	1mV (0~100V) 10mV (100~240V)	1mV (0~100V) 10mV (100~240V)	1mV (0~100V) 10mV (100~240V)	1mV (0~100V) 10mV (100~240V)	1mV (0~100V) 10mV (100~240V)
Accuracy	0.1%+8mV	0.1%+8mV	0.1%+8mV	0.1%+8mV	0.1%+8mV	0.1%+8mV	0.1%+8mV
Power Measurement							
Range	0~1500W	0~2000W	0~1000W	0~2400W	0~3000W	0~4000W	0~5000W
Resolution							
@P<100W	1mW	1mW	1mW	1mW	1mW	1mW	1mW
@P≥100W	10mW	10mW	10mW	10mW	10mW	10mW	10mW
@P≥1000W	100mW	100mW	100mW	100mW	100mW	100mW	100mW
Accuracy	0.2%+600mW	0.2%+600mW	0.2%+600mW	0.2%+600mW	0.2%+600mW	0.2%+600mW	0.2%+600mW
Current Slew Rate							
Range ^{*3}							
CCH	1mA/us~10A/us	1mA/us~15A/us	1mA/us~7.5A/us	1mA/us~16A/us	1mA/us~18A/us	1mA/us~20A/us	1mA/us~22A/us
CCL ^{*2}	100uA/us~600mA/us	100uA/us~600mA/us	100uA/us~600mA/us	100uA/us~600mA/us	100uA/us~600mA/us	100uA/us~600mA/us	100uA/us~600mA/us
Resolution ^{*4}	1mA/us	1mA/us	1mA/us	1mA/us	1mA/us	1mA/us	1mA/us
Accuracy	3% + 10us	3% + 10us	3% + 10us	3% + 10us	3% + 10us	3% + 10us	3% + 10us
Transient Operation							

Transient Mode	Continuous, Pulse, Toggled	Continuous, Pulse, Toggled	Continuous, Pulse, Toggled	Continuous, Pulse, Toggled	Continuous, Pulse, Toggled	Continuous, Pulse, Toggled	Continuous, Pulse, Toggled
Frequency Rang	0.025Hz~50kHz	0.025Hz~50kHz	0.025Hz~50kHz	0.025Hz~50kHz	0.025Hz~50kHz	0.025Hz~50kHz	0.025Hz~50kHz
High/Low Level Time	10us~10s	10us~10s	10us~10s	10us~10s	10us~10s	10us~10s	10us~10s
Resolution	10us	10us	10us	10us	10us	10us	10us
Accuracy	0.2%+10us	0.2%+10us	0.2%+10us	0.2%+10us	0.2%+10us	0.2%+10us	0.2%+10us
raise/ falling edge	10us~10s	10us~10s	10us~10s	10us~10s	10us~10s	10us~10s	10us~10s
Resolution	10us	10us	10us	10us	10us	10us	10us
Accuracy	0.2%+10us	0.2%+10us	0.2%+10us	0.2%+10us	0.2%+10us	0.2%+10us	0.2%+10us
List Operation							
Step Time	10us~99999s	10us~99999s	10us~99999s	10us~99999s	10us~99999s	10us~99999s	10us~99999s
Resolution	10us	10us	10us	10us	10us	10us	10us
Accuracy	0.2%+10us	0.2%+10us	0.2%+10us	0.2%+10us	0.2%+10us	0.2%+10us	0.2%+10us
Number of Steps	1~50 Steps	1~50 Steps	1~50 Steps	1~50 Steps	1~50 Steps	1~50 Steps	1~50 Steps
Cycle	1~255	1~255	1~255	1~255	1~255	1~255	1~255
Store Capacity	10Groupsd	10Groupsd	10Groupsd	10Groupsd	10Groupsd	10Groupsd	10Groupsd
Expansion Function	Chain	Chain	Chain	Chain	Chain	Chain	Chain
Maximum Slew Rate							

Current	10A/us	15A/us	7.5A/us	16A/us	18A/us	20A/us	22A/us
Voltage	0.5V/us	0.6V/us	0.5V/us	0.6V/us	0.6V/us	0.6V/us	0.6V/us
Programmable Open Circuit	$\geq 20k\ \Omega$	$\geq 20k\ \Omega$	$\geq 20k\ \Omega$	$\geq 20k\ \Omega$	$\geq 20k\ \Omega$	$\geq 20k\ \Omega$	$\geq 20k\ \Omega$
Trigger Input							
Trigger Level	TTL falling edge	TTL falling edge	TTL falling edge	TTL falling edge	TTL falling edge	TTL falling edge	TTL falling edge
Trigger Pulse Width	$\geq 10\mu s$	$\geq 10\mu s$	$\geq 10\mu s$	$\geq 10\mu s$	$\geq 10\mu s$	$\geq 10\mu s$	$\geq 10\mu s$
Maximum DC Input							
Current	101A	151A	76A	161A	181A	241A	261A
Voltage	242V	242V	242V	242V	242V	242V	242V
Protection and Alarm Function	OC, OT, OP	OC, OT, OP	OC, OT, OP	OC, OT, OP	OC, OT, OP	OC, OT, OP	OC, OT, OP
Alarm Function	OV, RV	OV, RV	OV, RV	OV, RV	OV, RV	OV, RV	OV, RV
Reverse Current Capacity							
Input OFF	90A	120A	60A	120A	150A	200A	220A
Input ON	100A	150A	75A	160A	180A	240A	260A
Ripple & Noise							
Current (rms/p-p)	3mA/30mA	3mA/30mA	3mA/30mA	3mA/30mA	5mA/30mA	8mA/30mA	8mA/30mA
Voltage (rms)	5mV	5mV	5mV	5mV	5mV	5mV	5mV

Environmental Conditions							
Temperature ^{*1}	0~50°C	0~50°C	0~50°C	0~50°C	0~50°C	0~50°C	0~50°C
Relative Humidity	≤85%	≤85%	≤85%	≤85%	≤85%	≤85%	≤85%
Remote Interface ^{*5}	RS232, GPIB, USB	RS232, GPIB, USB	RS232, GPIB, USB	RS232, GPIB, USB	RS232, GPIB, USB	RS232, GPIB, USB	RS232, GPIB, USB
Programmable Language	SCPI	SCPI	SCPI	SCPI	SCPI	SCPI	SCPI
AC Input							
Voltage	(AC110V, AC120V, AC220V, AC240V) ±10%	(AC110V, AC120V, AC220V, AC240V) ±10%	(AC110V, AC120V, AC220V, AC240V) ±10%	(AC110V, AC120V, AC220V, AC240V) ±10%	(AC110V, AC120V, AC220V, AC240V) ±10%	(AC110V, AC120V, AC220V, AC240V) ±10%	(AC110V, AC120V, AC220V, AC240V) ±10%
Frequency	48 to 63Hz	48 to 63Hz	48 to 63Hz	48 to 63Hz	48 to 63Hz	48 to 63Hz	48 to 63Hz
Input Power	80VA	80VA	80VA	80VA	130VA	130VA	130VA
Outline Dimension							
Net Weight	24kg	26.5kg	24kg	38kg	38kg	42kg	45kg
Frame	Fig1	Fig 1	Fig 1	Fig 1	Fig 2	Fig 2	Fig 2

- *1. The maximum continuous input power can reach the rated power at 40°C; the maximum continuous input power will linearly decrease from 100% to 75% between 40°C to 50°C.
- *2. The current change rate is 600mA/us in CCL mode.
- *3. The transition time is defined as the time required for the input to change from 10% to 90%.
- *4. The transient frequency depends on the high/low level time and the time for rising/falling edge.
- *5. Standard equipped RS232 and USB cable, optional equipped GPIB card.

Frame Diagram

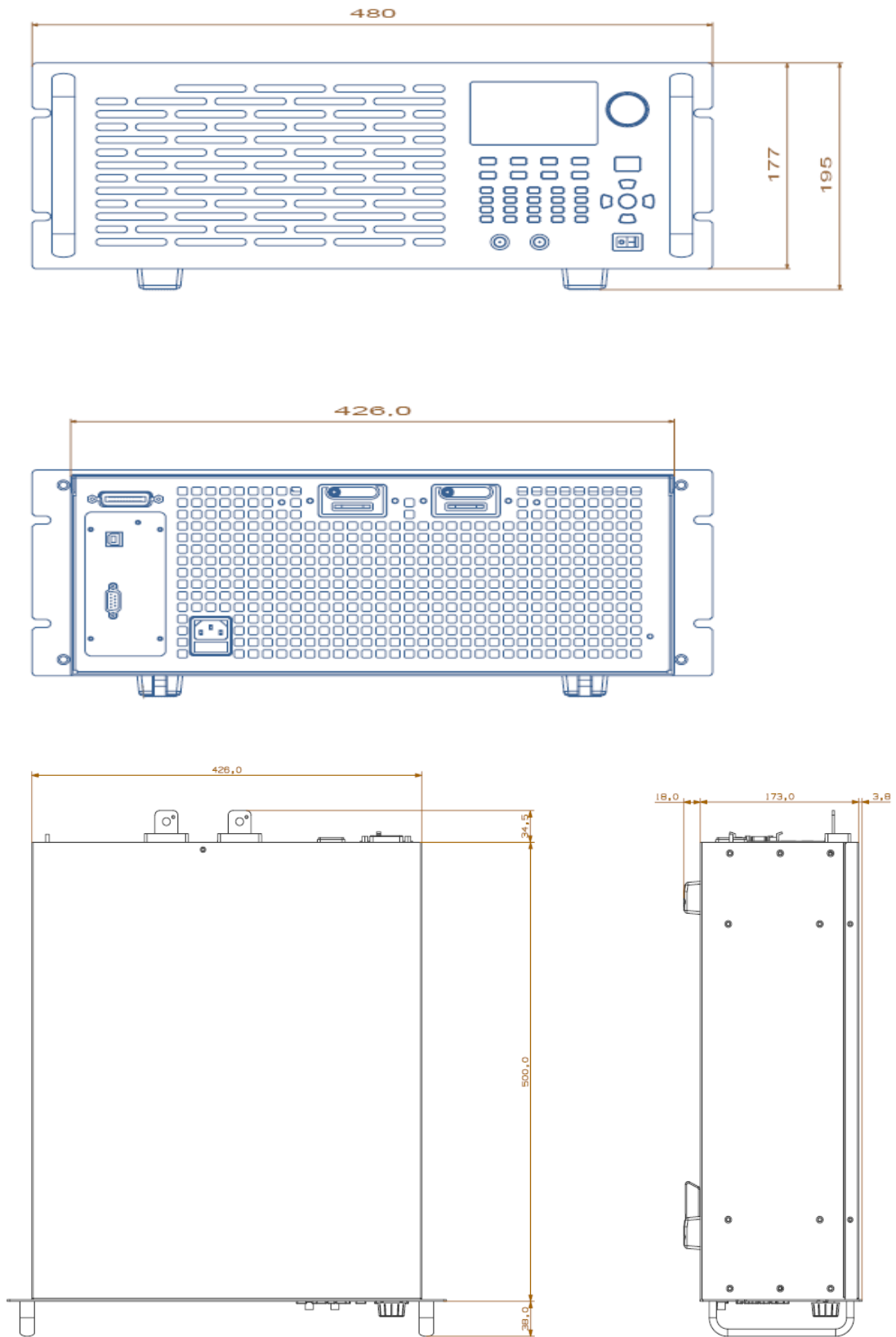
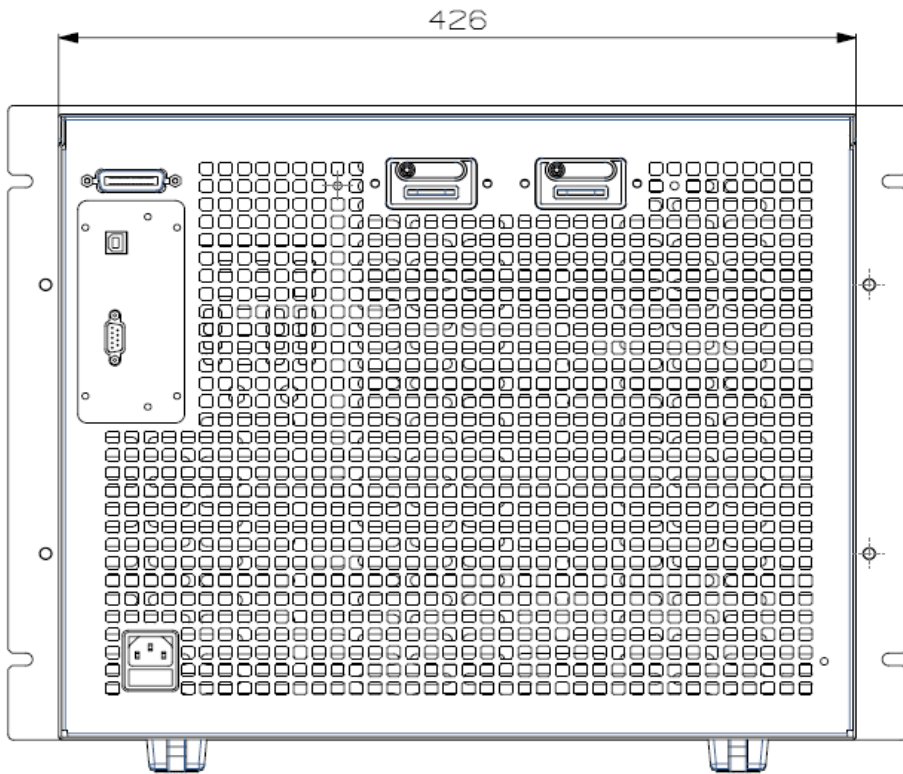
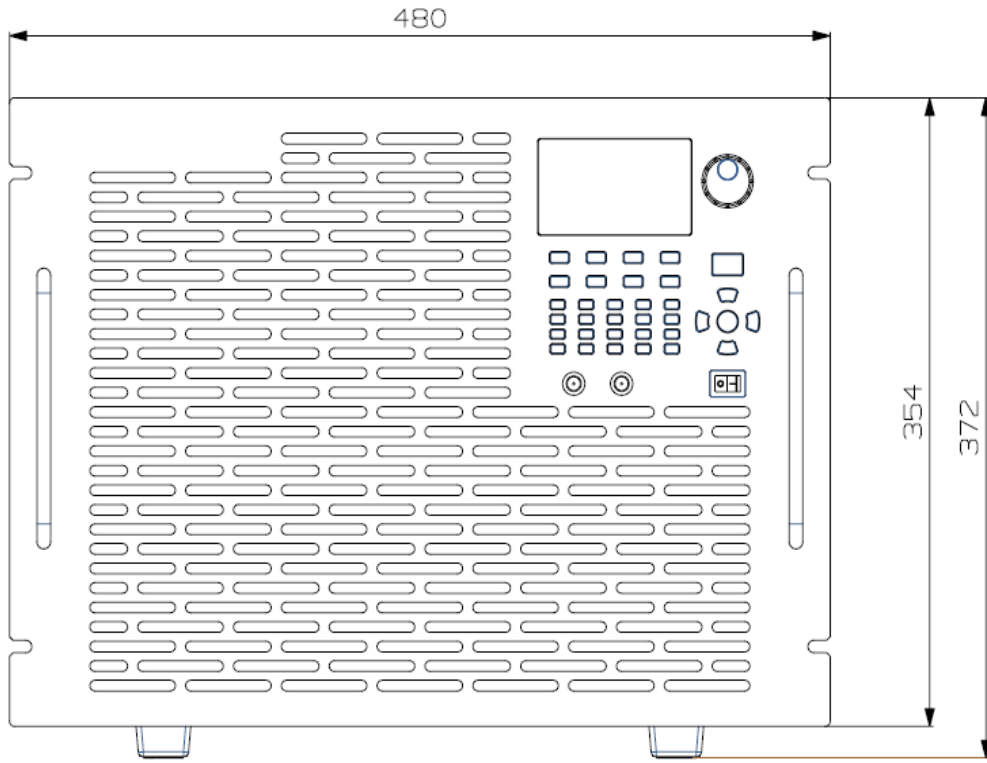

Fig. 1



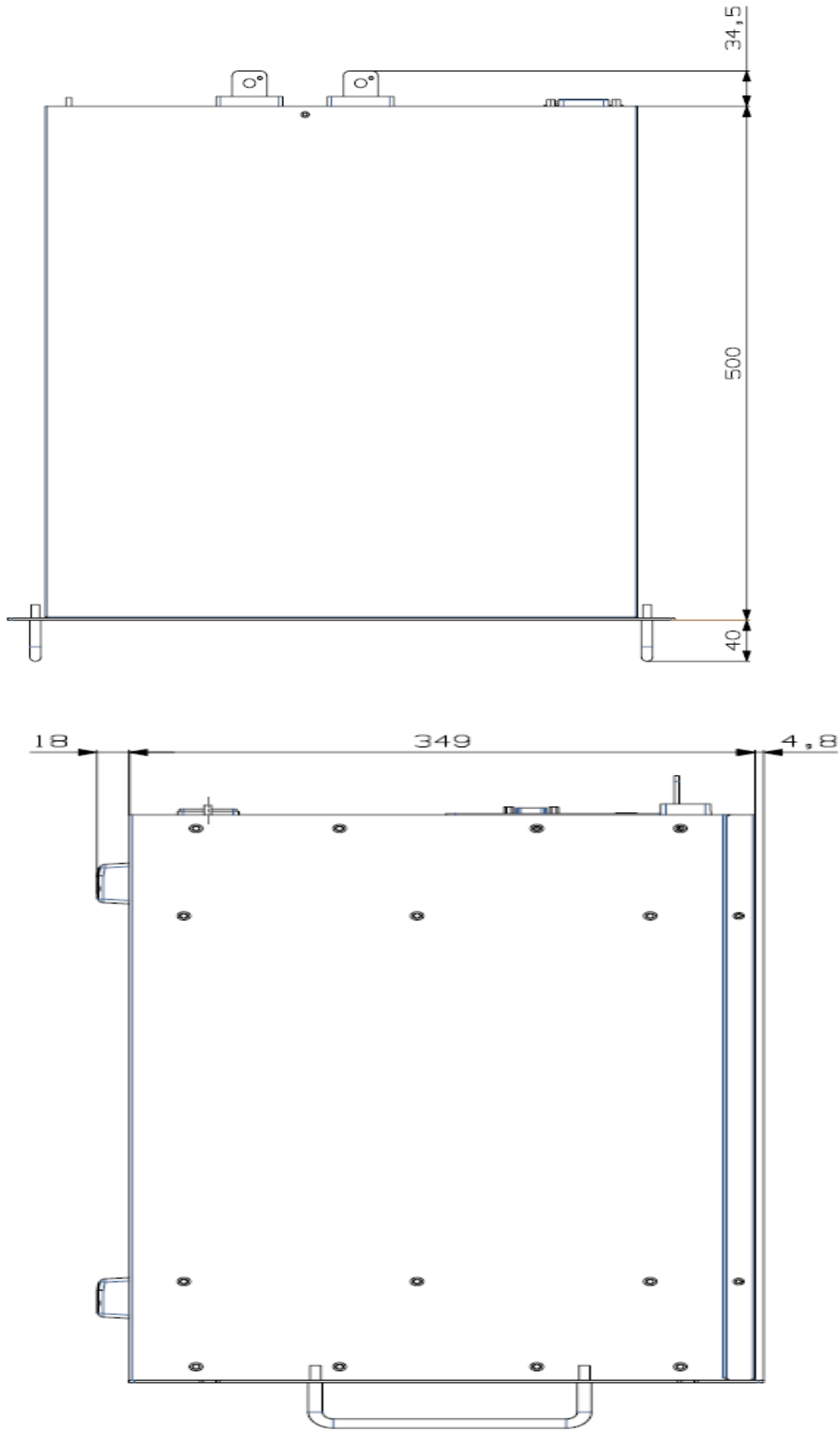



Fig. 2

Declarations

Toxic or Hazardous Substances and Elements in Electronic Information Products

 Part Name	Toxic or Hazardous Substances and Elements					
	Lead (Pb)	Mercury (Hg)	Cadmium (Cd)	Hexavalent Chromium (Cr(VI))	Polybrominated Biphenyls (PBB)	Polybrominated Biphenyl Ethers (PBDE)
Shell	○	○	○	○	○	○
PCB Assemblies*	×	○	○	○	○	○
Power Cable	×	○	○	○	○	○
CD, Printing, Packing	○	○	○	○	○	○

*: PCB assemblies include the printing circuit board and its components, such like resistances, capacitance, ICs, connectors and so on.

○: Indicates that this toxic or hazardous substance contained in all the homogeneous materials for this part, according to EIP-A, EIP-B, EIP-C is below the limit requirement in SJ/T11363-2006.

×: Indicates that this toxic or hazardous substance contained in all the homogeneous materials for this part, according to EIP-A, EIP-B, EIP-C is above the limit requirement in SJ/T11363-2006.

Parts with × in the above table, containing lead, because it is without mature replacement in instrumental industrial.

Notes:

Some parts of the table may not be your standard equipment, please refer to the actual packing box fittings shall prevail.

The start date of environmental protection period shall be based on the production date of the product, and the parts that are unable to inquire the production date directly from the product itself shall be based on the production

date of the equipment. The environmental protection period of the products in normal use will be up to 10 years. After the environmental protection period, please do a good classified work to the Recyclable and Unrecyclable items to protect the environment.

RECORDS				
DATE	REVISION	EDITION	DESCRIPTION	ECO NO
2016-04-13	A0	0	INITIAL VERSION	N/A
2017.01.16	A1	1	ADD MODEL	N/A

